

AT-640 User Manual

ISSUE 1.0

2011-07-28

1st.	AT-640's Network Features.....	4
1、	The View.....	4
2、	Interfaces.....	5
3、	Hardware.....	5
4、	Software.....	5
5、	Network.....	6
6、	Management and Maintenance.....	6
7、	Protocol.....	6
8、	Compliant Standard.....	7
9、	Operating Requirement.....	7
10、	Packing List.....	7
11、	Installation.....	7
2nd.	Feet installation instruction.....	8
3rd.	Keypad of IP Phone.....	11
4th.	BLF indicator status.....	12
5th.	Menu Operation.....	13
6th.	Basic functions and operations.....	18
1、	Answer the calls.....	18
2、	Make Call.....	19
3、	Speed dial.....	19
4、	Multiple line dial-up.....	20
5、	Hang up the phone.....	20
6、	Call Transfer.....	20
7、	Call Hold.....	21
8、	3-Way Conference Calls.....	22
9、	Call History.....	22
10、	Call pickup.....	23
11、	Join call.....	23
12、	Redial/Unredial.....	23
13、	vport.....	24
14、	Click to dial.....	25
15、	SMS function.....	25
16、	Default Password.....	26
17、	Check the Phone's IP.....	26
7th.	Web settings.....	26
1、	Current state.....	27
2、	Network.....	27

2.1.	Wan Config.....	27
2.2.	LAN Config.....	29
3、	VoIP.....	30
3.1.	SIP1/SIP2/SIP3/SIP4.....	30
3.2.	Iax2 Config.....	33
4、	Advanced.....	34
4.1.	DHCP Server.....	34
4.2.	NAT.....	35
4.3.	Net Service.....	38
4.4.	Firewall.....	38
4.5.	Qos.....	39
4.6.	Digital Map.....	41
4.7.	Stun.....	42
4.8.	Call Service.....	43
4.9.	MMI Filter.....	44
4.10.	Audio Settings.....	45
4.11.	VPN.....	46
5、	Dial Peer.....	47
6、	Config Manage.....	49
7、	Update.....	49
7.1.	Web Update.....	49
7.2.	FTP/TFTP Update.....	50
7.3.	Auto Provisioning.....	51
8、	System Manage.....	52
8.1.	Account Manage.....	52
8.2.	Phone Book.....	54
8.3.	Multi Line Set.....	54
8.4.	Function Key Set.....	55
8.5.	Syslog Config.....	57
8.6.	Time Set.....	58
8.7.	Call Log.....	59
8.8.	Language Set.....	59
8.9.	Logout.....	60
8.10.	Reboot.....	60

1st. AT-640's Network Features

1、The View



AT640



AT640 with expander board

2、 Interfaces

- Power: Output Power: 12VDC, 500mA DC
- WAN: RJ45 port
- LAN: RJ45 port
- Extended interface for BLF module: 2
- Headset jack : RJ9 port
- Handset jack : RJ9 port

3、 Hardware

- LCD: 128×64 dot matrix
- FLASH: 4M
- RAM: 16×16M
- LED indicator: 1 Status Light , 9 BLF indicator, 1 voicemail indicator, 1 headset indicator, 1 mute indicator, 1 handfree indicator

4、 Software

- Sip 2.0 (RFC3261) and other related SIP RFC
- 4 lines SIP
- 1 line IAX2
- STUN
- Jitter Buffer(200ms),VAD,CNG
- G.711A/u, G722, G.723, G.726-32, G.729 Codec
- G.168 compliant 96ms echo cancellation
- Support SIP domain, SIP authentication(none, basic,MD5),NDS.
- Support inbound audio, RFC2833 and SIP info , DTMF transmission way
- SIP Call Forward、Call transfer、Call hold、Call waiting, 3-way talking、Pickup、Join call、Redial、Unredial、Call Park、Vport、Click to dial
- Dial without register
- Support Hotline、DND(Do Not Disturb)、Blacklists、Call Limitation、Caller ID
- Dial-peer calling rule, IP to IP call
- SIP server conference
- Phone book with 500 records, 100 answered call、100 missed call
- Support HTTP、FTP TFTP updating the configuration and firmware
- Syslog
- Auto answer
- Support SNMP client
- Telnet, WEB visit terminal
- Support different level user management

- Support multi language (LCD support Latin language system, web support all languages)
- soft button: soft button * 4
- Support BLF/BLA
- Support SMS
- Support auto provision (option 66) for config file upgrade

5、 Network

- WAN/LAN: Support bridge and route mode
- Support base of NAT and NAPT
- Support PPPoE, (ADSL, cable modem use for internet connecting)
- Support VLAN (DATA VLAN and VOICE VLAN)
- Support DMZ
- Support L2TP VPN (OpenVPN optional)
- WAN support Primary and Alter function
- WAN support DHCP Client
- LAN support DHCP Server
- Qos support Diffserv
- Support Network command tool: include ping, trace route, telnet

6、 Management and Maintenance

- Support safe mode(POST Mode) and firmware updating under safe mode
- Support different level user management
- Configuration via web , keyboard and command
- Support multi language (LCD support Latin language system, web support all languages) and easy dynamic switch between different languages
- Firmware and configuration updating via HTTP , FTP and TFTP
- Support system log and call log
- Firmware and configuration file auto provision

7、 Protocol

- IEEE 802.3 /802.3 u 10 Base T / 100Base TX
- PPPoE: PPP over Ethernet
- WAN support DHCP Client and Server
- SIP RFC3261, RFC3262, RFC3263, RFC3264, RFC3265, RFC2543, RFC3489, RFC3842, RFC3515, RFC2976, RFC3428, RFC2327, RFC2782, RFC1889
- TCP/IP: Transfer Control Protocol/Internet Protocol
- RTP: Real-time Transport Protocol

- RTCP: RTP Control Protocol
- VAD/CNG
- Telnet: remote host access protocol
- DNS: Domain Name Server
- TFTP: Trivial File Transfer Protocol
- HTTP: Hypertext Transfer Protocol
- FTP: File Transfer Protocol

8、 Compliant Standard

- CE: EN55024,EN55022
- FCC part15
- Comply with ROHS in EU
- Comply with ROHS in China



Explanation:

The letter "e" is the first letter of "environment: and "electronic". The rim is a round with two arrow, stands for recycle. The number 20 stands for the years of environment protection. Please note the years of environment protection is not discarding year nor usage life.

9、 Operating Requirement

- Operation temperature: 0 to 40° C (32° to 104° F)
- Storage temperature: -30° to 65° C (-22° to 149° F)
- Humidity: 10 to 90% no dew

10、 Packing List

- AT-640 IP phone
- Power adaptor (output 12v ,500mA)
- Manual CD

11、 Installation

Use Ethernet cable to connect AT-640's LAN port and your computer. Set computer's IP to the network 192.168.10.x or using dynamic obtain IP. Open web browser and key in 192.168.10.1. Then user will see the login page of AT-640, the default

username and password is admin/admin for administrator and guest/guest for guest.

Set up page for VoIP user only:

AT640 WAN default to use DHCP, and after connect WAN to Switch, it will obtain IP automatically. Press the down key of navigation button, you will see AT640's IP. Then type the ip in your web browser, you will see the login page.

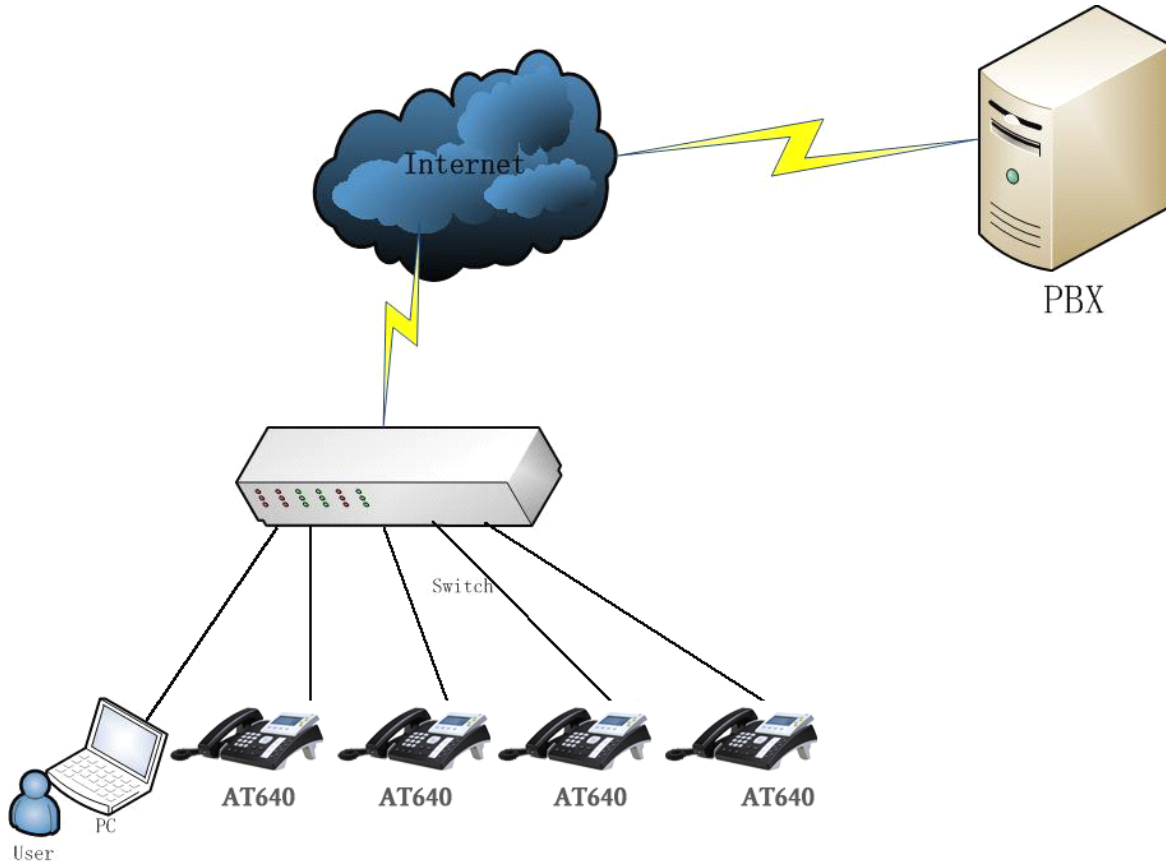

2nd、 Feet installation instruction

1、 Desktop position:

- A、 Put the bottom side of the IP phone upside and press the plate with letter "PUSH" into the slot, please refer the picture as below:

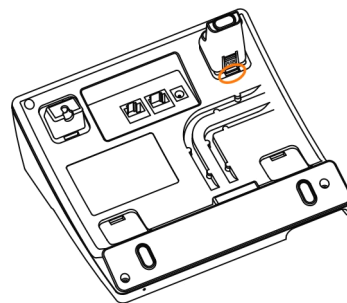

- B、 Press the other plate into the slot in accordance with the direction of the arrow

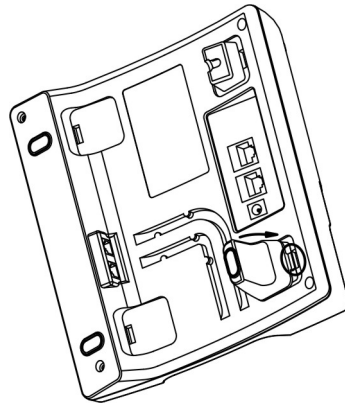

- C、 Repeat A and B. It is the right picture of putting on desk after fixing the two feet below:

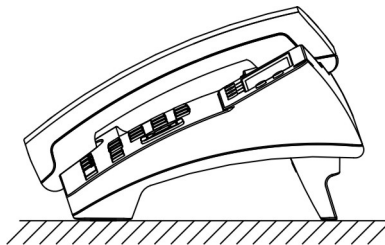

- D、 Disassemble the feet:

Press the plate with word "PUSH" and pull the feet with the direction of arrow. When the plate is pull out of the slot (there will be a sound of "pa") you can take off the feet

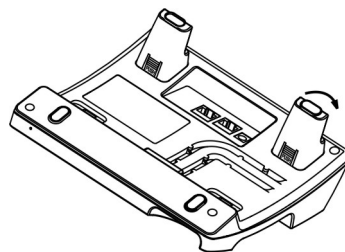

2、 On wall postion

- A、 Put the bottom side of the IP phone upside and push the plate with letter "PUSH" into the slot, please refer the picture as below:

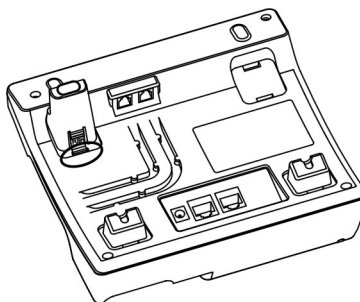

- B、 Push the other plate into the slot in accordance with the direction of the arrow

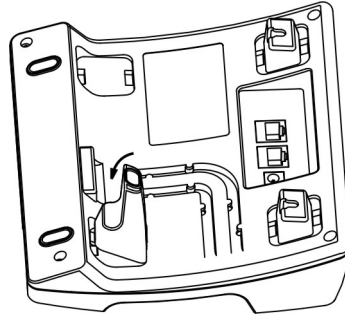

C、 Repeat A and B. It is the picture of wall mounting after fixing the two feet below:

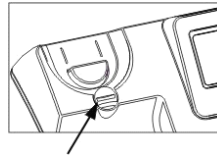
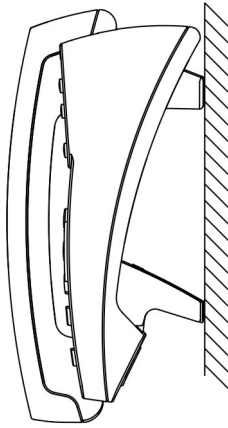

Attention: Please rotate the hook to the position as in picture with a coin or other tools

D、 Disassemble the feet way:

Press the plate with word "PUSH" and pull the feet with the direction of arrow. When the plate is pull out of the slot (there will be a sound of "pa") you can take off the feet

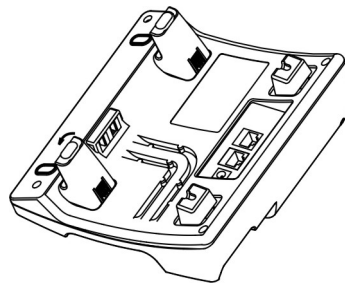

3rd、 Keypad of IP Phone

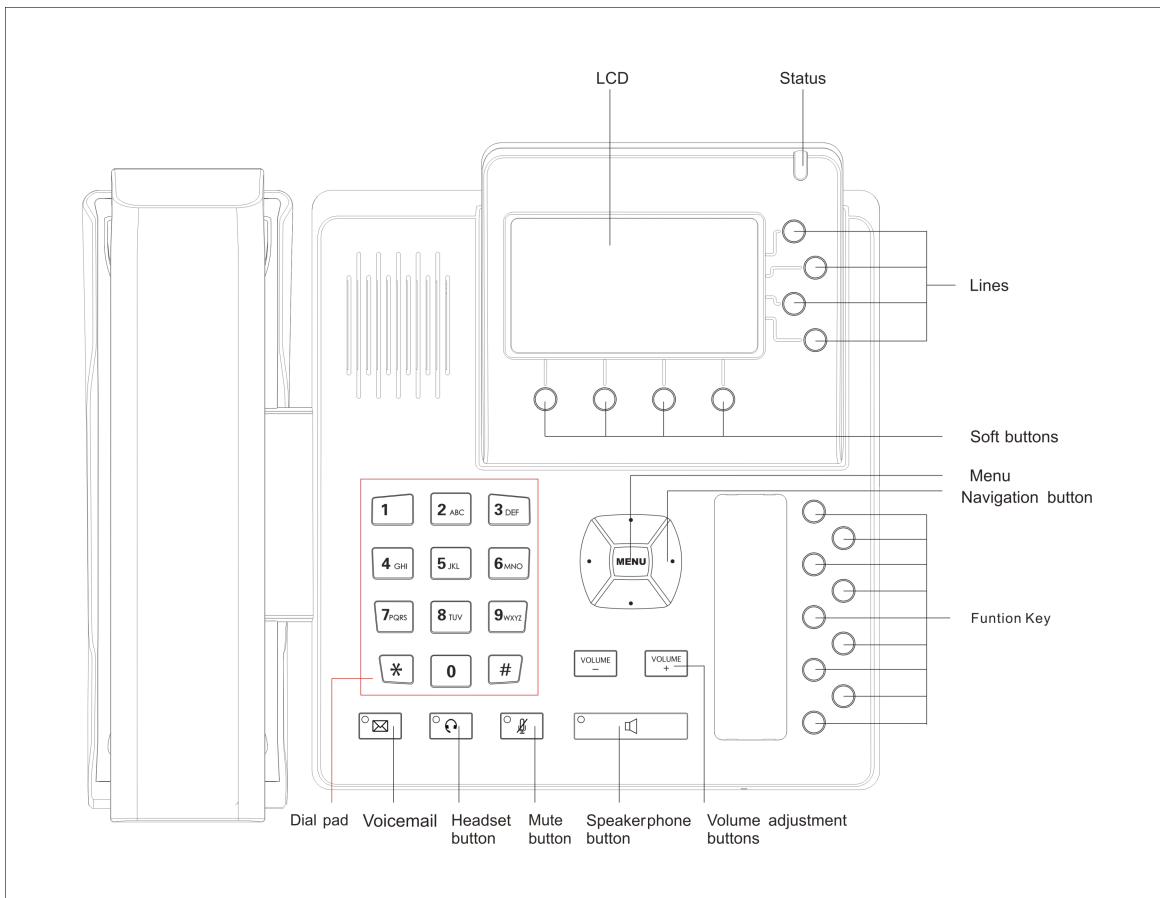

Describe of the buttons and Screen:

Soft buttons	Press to select an feature shown in the soft button features
Soft button features	Shows available choices based on current phone function displayed on the last line of LCD screen
Status	Shows the phone status, if the phone is standby, the LED is with light. If there is income calling, the LED will flicker. <ul style="list-style-type: none"> ➤ If the phone is starting ,the LED is flicker ➤ If the phone is standby, the LED is off ➤ If there is income calling, the LED will flicker. The frequency is 500ms off, 500ms on. ➤ When have voicemail, LED shows red and flicker, and the frequency is 1000ms off, 1000ms on. ➤ If the phone not obtain the IP address, the LED is ON
LCD Screen	Display screen for the phone: It shows the date, time, phone number, incoming caller's ID(if available),line/call status,

	extension numbers and the soft button features.
Lines	Shows extension number and status. There are three colors for LED, red, yellow and orange. <ul style="list-style-type: none"> ➤ If the line is registered, the LED shows yellow ➤ If the line is enable registered but register to server failed, the LED shows orange ➤ If the line has income calling, the LED shows red and flicker ➤ If the line is on the calling , the LED shows red ➤ If the line disable for register, the LED is off. ➤ when there is the incoming call , LED blinks, The frequency is 500ms off,500ms on. ➤ When have voicemail, LED shows red and flicker , The frequency is 1000ms off,1000ms on.
Navigation button	Allows users to navigate(left, right, up, down), on the standby, up and down shows the network information, right shows the lines information, left shows the call record
Dial pad	For entering numbers, letters or characters
Function Key	All the function key can be defined as memory key/line/key event to realize different function.
Menu	Come into Keypad menu
Volume buttons	Adjust the volume
Speakerphone button	Pick up and hung up on the speakerphone mode, when pick up by speakerphone, the LED of the button is on
Mute button	Mute the handset, headset or speakerphone by press the Mute button; this prevents the person on the active call form hearing what you or someone else in the room is saying. To cancel the Mute function, press the Mute button again. If Mute the voice, the LED is light on this button
Headset button	Pick up and hung up on headset mode. When pick up by headset, the LED button will light
Voicemail button	Check the Voicemail status, if there are voicemail, the button will light

4th、 BLF indicator status

1.AT640 support BLF in two ways, one is integrated on the ipphone, the other one is extended interface.

The BLF indicator status:

Table 1 Call /Line Appearance Button LEDs for BLF

LED Status	Description
Steady green	Call/line appearance is in idle status
Slow blinking red	Call/line appearance is ringing
Steady red	Call/line appearance is active
Fast blinking red	Call/line appearance is not available
Off	It is not active as call/line appearance

- When boot up,all the light blink for once.
- When phone is stand by,all the light are off.
- When there is a coming call,the corresponding line key and status light will blink.

5th、 Menu Operation

Head Menu	Secondary menu	Level 3 Menu	Level 4 Menu
When Stand by			
Dial			
	Next		
	Dial		
	OK		
	Quit		
DIR (phone book)			
	List Is Empty (when no item saved)		
		Add	
			Del(delete)
			Save
			Exit
		Quit	
	Dial		
	Del		
		One	
		All	
		Exit	
	OK		
		Dial	
		Edit	

			Del
			Save
			Exit
		EDia(edit number before dial)	
			Del
			Dial
			Exit
		Exit	
	Quit		
DND(Do not disturb)			
	-Dnd (Cancel DND)		
More			
	FWD (call forward)		
		SIP1 FWD to:	
		SIP2 FWD to:	
		SIP3 FWD to:	
		SIP4 FWD to:	
			OFF
			ON
			123/ALL/ABC/abc (input mode)
			Quit
	SMS(Message)		
		New	
		OK	
			Del
			Send
			Exit
		Quit	
	More		
When off-hook			
Dial			
DIR			
When dial			
Dial			
Del			
CLR(Clear)			
Exit			
When called			

Ans(Answer the call)			
Deny(refuse to answer the call)			
Call state			
Conf(Conference)			
	Clog		
	DIR		
	FWD		
	Retr		
Xfer(Call transfer)			
	Xfer		
	Del		
	Bxfr (Blind Transfer)		
	Exit		
Hold(hold the call)			
	Resu (Resume the call)		
Have missed call			
	LCR(Call back)		
	Miss (Enter missed call)		
Press "Menu"			
Next			
OK			
Quit			
Menu display			
01 PhoneBook			
	Dial		
	Del		
	OK		
	Exit		
02 Speed Dial			
	Del		
		One	
		All	
		Exit	
	Edit		
		Del	
		Save	
		Exit	
	Exit		

03 Call history			
Next			
OK			
Exit			
	01 Outgoing Call		
		Dial	
		Del	
		OK	
		Exit	
	02 Incoming Call		
		Dial	
		Del	
		OK	
		Exit	
	03 Missed call		
		Dial	
		Del	
		OK	
		Exit	
04 Preferences			
	01 Do Not Disturb		
		Edit	
		Exit	
	02 Call Forward		
		Mode	
		Number	
	03 Call Waiting		
	04 Hotline		
	05 Dial Rule		
		01 End With *	
		02 Fixed Length	
			01 Enable Fixed Length
			02 Fixed Length Value
		03 Time Out	
			01 Enable Time Out
			02 Time Out Value
Network			
	01 Net Mode		
		Static	
		DHCP	

		PPPoE	
	02 Static Set		
		01 IP	
		02 Netmask	
		03 Gateway	
		04 DNS	
	03 PPPoE Set		
		01 Account	
		02 Password	
	04 VLAN		
06 SIP Set			
	01 SIP1		
		01 SIP Name	
		02 SIP Server	
		03 SIP Server Port	
		04 SIP Number	
		05 SIP Account	
		06 SIP Password	
		07 SIP Register	
	02 SIP2		
		01 SIP Name	
		02 SIP Server	
		03 SIP Server Port	
		04 SIP Number	
		05 SIP Account	
		06 SIP Password	
		07 SIP Register	
	03 SIP3		
		01 SIP Name	
		02 SIP Server	
		03 SIP Server Port	
		04 SIP Number	
		05 SIP Account	
		06 SIP Password	
		07 SIP Register	
	04 SIP4		
		01 SIP Name	
		02 SIP Server	
		03 SIP Server Port	

		04 SIP Number	
		05 SIP Account	
		06 SIP Password	
		07 SIP Register	
07 Phone Set			
	01 Screen Set		
		01 Contrast	
		02 Brightness	
	02 Ringer Set		
		01 Ringer Volume	
		02 Ringer Type	
	03 Volume Control		
		01 Voice Volume	
		02 Mic Volume	
08 Product Info			
	01 Mac Address		
	02 System Version		
	03 Model Information		
	04 Network Status		
	05 SIP Status		
	06 IAX2 Status		
09 System Config			
	01 Menu Password		
	02 KeyLock Password		
	03 Reboot System		
	04 Factory Reset		

6th、 Basic functions and operations

1、 Answer the calls

When there is an incoming call, AT640 will remind user with ringing. There are 5 ways to answer the call

A、 Answer by handset

Pick up the handset and talk with the caller. If you want to hang up, just put back the handset.

B、 Hand-free mode

Press the hand-free button in the phone and talk with callers by built-in Micro-phone and Speaker. If you want to hang up, please press the hand-free

button again.

C、 Answer by earphone

Keep your earphone connected with the RJ9 earphone jack, when there is an incoming call, press the earphone button on the IP phone and talk with the caller. If you want to hang up, please press the earphone button again.

D、 Handset to hand-free

When you are phoning with the handset and want to phone with hand-free mode, please press the hand-free button and put down the handset.

E、 Hand-free mode to handset

If you are calling under hand-free mode and want to change to speaker phone, just pick up the handset without press any buttons.

2、 Make Call

A、 Use the handset

Pickup the handset, the LCD will show the current lines (user could switch between line1 to line4 by pressing the line button beside the LCD). User can input the number with the keyboard and press # to send the number. When you hear the tones of "du~~du~~" with dialed number showed on the LCD, the called's phone is ringing. If the called answer the call, the phone call is established and the LCD will show the calling time and the called's number.

B、 Answer the phone under hand-free mode

Press the Speaker Phone button, the LCD will show the current lines (user could switch between line1 and line2 by pressing the line button beside the LCD). User can input the number with the keyboard and press # to send the number. When caller hear the tones of "du~~du~~" with dialed number showed on the LCD, the called's phone is ringing. If the called answers the call, the phone call is established, and the LCD will show the calling time and the called's number.

C、 Used phone book

- a、 Pick up the handset.
- b、 Press " Menu" button and use the "up" and "down" keys to enter phonebook.
- c、 Press "OK" to show the total amount in telephone.
- d、 Press "OK" to enter the phone list and use "up" and "down" keys to find the contact person.
- e、 When you find the certain contact person, press" OK" to show the details.
- f、 Press "Edit" to edit the number or press" Dial" to call.

3、 Speed dial

It's method for the phone in standby mode to dial number immediacy.

The method is as below:

- A、 Dial-up the number in standby mode
- B、 Push soft button "dail", "#"key or hang up directly to send the dial number.
- C、 Push soft button to save the number in telephone directory.

4、 Multiple line dial-up

AT640 IP phone supports 4 Sip lines. That means user can register on 4 different sip accounts simultaneously in the same IP phone. The User can choose line1 、 line2 、 line 3 or line 4 to switch dial-up, System default Sip1 when dial-up.

IP Phone be called:

AT-640 maximum supports one incoming call when it is called, when the second line calling, the LCD will show the incoming telephone number. The User can press the "corresponding line key" indicated by LED flicker, or press soft button "ANS" to receive the second line call, when two calls coming together, press soft button "SWIT" to Switch.

Notice:

The phone must work with Call Waiting function when work for this feature.

5、 Hang up the phone

1) Headset hang up

When use headset mode calling, put back the handset to hang up.

2) Hands free hang up

When use hands free calling, press soft button "speaker phone" to hang up.

3) Earphone Hang up

When use Earphone calling, Press the soft button "headset" to hang up.

4) Hang up one line call

When 2 lines call simultaneous, press soft button "SWIT" to choose the line which you want to hang up, then press soft button "#" to end the call. In the mean time, it will automatic switch to another line and continue call. Moreover, user can redial-up or accept the second call.

Notice:

Hang up with "#" is invalidation when only one line call.

6、 Call Transfer

➤ Blind Transfer

User A.B.C, assume B is AT-640 IP phone

- 1) When A Calls B and B receives
- 2) B presses soft button "Xfer"

- 3) B dials C's number.
- 4) After dialing C, B Presses soft button "Bxfr" (or wait for a few seconds after dial number), then the call will be transfered to C.
- 5) When C's phone ring, B will be hung up , the LCD on B's Phone shows "Pls. Hang Up".
- 6) C receives the call, start to talk with A.

Notice:

SIP lines are not available for choosing when call transfer.

➤ Attended Transfer

User A.B.C, assume B is AT-640 Ip phone

- 1) When A Calls B and B receives
- 2) B presses soft button "Xfer" .
- 3) B dials C's number and C receives to talk with B.
- 4) B can press "Swit" to switch the call between A and C.
- 5) B Presses soft button "Xfer", then transfers the A's call to C.
- 6) Meanwhile The LCD on B's phone shows "Call Ended ".

Remarks:

To carry out this function, IP Phone must work with Call waiting and call transfer function; meanwhile Sip server must support RFC3515.

➤ Alert Transfer

User A.B.C, assume B is AT-640 Ip phone

- 1) When A Calls B with B receives.
- 2) B presses soft button "Xfer" when A is calling.
- 3) B dials C's number.
- 4) After dialing C, B directly Presses soft button "Xfer", then transfers the call to C.
- 5) C receives the phone, starts to talk to A.

Remarks:

To carry out this function, IP Phone must work with Call waiting and call transfer function; meanwhile Sip server must support RFC3515.

7、 Call Hold

User can hold the current call by pressing soft button "Hold". And by pressing soft button "Resu" , user can get back to the previous call. In 3-way conference call mode, user can also press this button to hold 3-way conference call, and if you press it again, user can go back to 3-way conference mode. If hang up without exiting the status of hold. The conversation will not be cancelled; the line is still on hold.

8、 3-Way Conference Calls

Assume B is AT-640 phone among user A,B and C.

A calls B and talks with B through VoIP.

- 1) B can press soft button "conf" to hold the call with A.
- 2) Then B inputs C's number.
- 3) B presses Soft button "dial" to call to C.
- 4) C is on the call with B and A is on hold.
- 5) B presses Soft button "Conf" button to make 3-way conference call.
- 6) B presses soft button "spli" to end 3-way conference call and returns to the call with A while C is holded. B can press "Swit" to switch the call between A and C.
- 7) B presses soft button "exit" to end all the calls.

9、 Call History

AT-640 supports 100 missed calls, incoming calls and dialed calls record. When the storage is full, the latest call will update the history. When the phone reboots or be out of power, all the call history will be cleared.

➤ Missed call

- 1) When the LCD screen displays "(number) Missed call(s)", press soft button "Miss", then the screen shows all the "Missed Call".
- 2) Press navigation button to browse missed call history.
- 3) Choose the missed call record, press "OK" soft button to browse the specific information of the record.
- 4) Press "Dial" soft button to call back it.
- 5) Press "Edit" soft button to edit the item and save number.
- 6) Press "EDia" soft button to revise the records and press soft button "dial" to call this number.

➤ Incoming call

Method 1,

- 1) Press the "MENU" button.
- 2) Press the navigation button to choose "call history" and then press OK button.
- 3) Press the navigation button to choose "incoming call", press soft button OK.
- 4) Press the navigation button to browse the incoming call record. If there is no record, the LCD screen display "List is Empty".

Method 2,

- 1) Press the left button of navigation button, you can see all the Incoming Call.

➤ Out coming call

Method 1,

- 1) Press "MENU"
- 2) Press up or down navigation key, and select call history and press soft button

“OK”

- 3) Select “Outgoing call” through “up” or “down” key, and press soft button “OK”
- 4) Press up or down navigation button and check the received calls, LCD will show “List is Empty”, if there is no received incoming call.

Method 2,

- 1) Press the left button of navigation button, you can see all the call history.
- 2) Press the left button again to switch between incoming Call, Outgoing Call and Missed Call.

10、 Call pickup

Call pickup is simulated from “Pickup” function processes from IPPBX. When A call B with no reply after ring tones, C could pick up the call from A for B by inputting the prefix and B’s phone No.

C needed to set the dial peer with prefix code as follow

Number	Destination	Port	Mode	Alias	Suffix	Del length
*1*T	0.0.0.0	5060	SIP	rep:pickup	no suffix	3

To refer *1* as the set prefix code, C could get the call from A to B by dialing *1*+B, *1* prefix could be freely set as long as no confliction with other dialing rules. Del Length is the digits of the prefix.

11、 Join call

“A” could join in the conference call, by input a prefix plus a phone No. which is already in the conference.

A requested to set the prefix code for dial peer as follow

Number	Destination	Port	Mode	Alias	Suffix	Del length
*2*T	0.0.0.0	5060	SIP	rep:joincall	no suffix	3

To refer *2* as the set prefix code, “A” could join in the conference by dial *2* plus the call No. which is already in the conference.

2 prefix could be freely set as long as no confliction with other dialing rules. Del Length is the digits of the prefix.

12、 Redial/Unredial

In order to being efficiently to contact the busy line, A could use Redial to call B the busy line with the prefix(for example *3*). When B is free A could get through

the call as usual. When B is busy, A could hang up the phone while A's phone keep checking B's situation every 60s. When B is available, A's phone will ring. It would call B automatically once A picking up handset.

A could dial B's number with the prefix (for example *4*) to cancel the call before the phone automatic redialing if A is not available suddenly or don't want to call B anymore.

Number	Destination	Port	Mode	Alias	Suffix	Del length
*3*T	0.0.0.0	5060	SIP	rep:redial	no suffix	3
*4*T	0.0.0.0	5060	SIP	rep:unredial	no suffix	3

3 is the prefix. Then A could make the redial function via dialing *3* + B's number.

4 is the prefix. Then A could make the unredial function via dialing *4* + B's number.

User could set any prefix if it is compliant with present dial rule. Del Length is the digits of the prefix.

13、 vport

Vport makes more flexible calling application. Eg. It could forward a call from Line 1 to one account of Line 2 after configuring forward type and number@line via web interface. The forward could make either from Line 1 to Line 2 or Line 2 to Line 1. But the end user may not aware the configuration being made therefore probably the end user should be advised that it may cost with the forward function. The forwarding could be done via either Line Key to select the line or dialing IP after calling under server. It could be implemented by the following ways:

◆ Point to Point Call Forward

Make the configuration like @ip:port in the column of Forward Number. Then it could make SIP call point to point with this IP and port in system. User could select forward type accordingly.

◆ Point to Point Blind Transfer

Transfer the call via dialing IP directly.

Call Forward, Call Transfer (Blind Transfer/ Attended Transfer) in different Line. Make the configuration like sip: username@n in the column of Forward Number. Then system would select Line N and make call accordingly.

SIP Line (eg:0/1/2. Or 0.0.0.0/0.0.0.1/0.0.0.2/255.255.255.255 which is compliant with former configuration).

Call Forward, Call Transfer (Blind Transfer/ Attended Transfer) between SIP Line and Point to Pint.

It is compliant for the Call Forward, Call Transfer (Blind Transfer/ Attended Transfer) between SIP Line and Point to Pint.

14、 Click to dial

When User A accesses web interface and calls User B via clicking a link which is direct to B, IP Phone of User A would ring and calls B automatically once A picking up handset(need server support).

15、 SMS function

➤ Create new SMS

- 1) press MORE (soft button 4)
- 2) press SMS(soft button 2)
- 3) press New(soft button 1)
- 4) Edit SMS context and you can switch the input method by press # such as ABC(capital letters) , abc (lower case letters) , 123 (number).
- 5) When the edit is done , press Send(soft button 2) and input receiver's phone number.
 - A、 press Sear(soft button 1) to find the contact person in phonebook
 - B、 directly input receiver's phone number
 - C、 Use P2P method , input # + IP address (press * twice to input #)
For example if you send the SMS to the phone with IP address of 192.168.1.88, you will press **192*168*1*88

After inputing receiver's address, press Send(soft button 2) to send out your message.

➤ SMS Check new SMS

When there is a new SMS, LCD will show New Message(S)

- 6) Press More(soft button 4).
- 7) Press MS(soft button 2) , LCD will display Number New Number old.
- 8) If there is a new SMS and 2 old SMS, LCD will display 1 New 2 Old.
- 9) Press OK (soft button2) to enter SMS list , if it's unread , there will be a NEW before it , or else it has been read.
- 10) Press up and down key in navigation keyboard to select the message and press OK(soft button2) to read it.
- 11) If you want to delete the SMS , just press Del(soft button 1) after you select it.
- 12) If you want to reply the message,just press Repl(soft button 2) after you select it.

Notice :

In SMS list, you can press quit (soft button) to go to the upper menu
Dial means dial to call sender directly when you are reading his SMS
Edia means call the sender after edit his number .
Edit means editing the SMS context.

16、 Default Password

There are 2 models to set the authority of web accessing and command line: Guest model and Admin model. User could view and configure all items in Admin mode. While guest couldn't change the SIP (1-2) and IAX2 configuration as well as server address and port but only access and view the information. User would enter different mode after input different user name and password:

- **Web interface:**

- Guest Model

Username: guest

Password: guest

- Admin Model:

Username: admin

Password: admin

- **Keypad password:** 123

17、 Check the Phone's IP

Press the up or down navigation button to check the phone's current IP address.

7th、 Web settings

Enter AT-640 IP addresses in the web browser to go to the log on page, and key in the username and password to access AT-640 setting page.

Default username and password is:

Administrator: Username: **admin** password: **admin**

User: Username: **guest** password: **guest**

1、 Current state



IP Phone

[Current Status](#)
[Network](#)
[VOIP](#)
[Advanced](#)
[Dial-peer](#)
[Config Manage](#)
[Update](#)
[System Manage](#)

Network			
WAN		LAN	
Connect Mode	DHCP	IP Address	192.168.10.1
MAC Address	00:09:45:5a:9a:94	DHCP Server	ON
IP Address	192.168.1.198		
Primary DNS	202.96.134.133		
Alternate DNS	202.96.128.68		
Gateway	192.168.1.254		

Phone Number		
SIP LINE 1	6111@192.168.1.99 :5060	Registered
SIP LINE 2	8003@192.168.1.203 :5060	Registered
SIP LINE 3	2404980645@as.iop1.broadworks.net :5060	Registered
SIP LINE 4	abc-123@192.168.1.244 :5060	Registered
IAX2	6008	Registered

Version: VOIP PHONE V1.7.367.149 Jul 4 2011 09:44:03

This page shows the IP phone working status.

The network part shows the connection status of WAN and LAN.

Phone Number part shows the phone number and register status for Line1、 Line2 and IAX2.

The Version shows the current firmware version.

2、 Network

2.1. Wan Config

There are 3 ways to connect to the internet DHCP, Static and PPPoE, please choose one according to your own situation.

A、 DHCP, the IP phone will get IP address from DHCP server , you do not have to fill in the date of IP address , net mask etc , just choose DHCP and submit . Please refer to the below picture.

IP Phone

[Current Status](#) |
 [Network](#) |
 [VOIP](#) |
 [Advanced](#) |
 [Dial-peer](#) |
 [Config Manage](#) |
 [Update](#) |
 [System Manage](#)

- WAN Config
- LAN Config

WAN Configuration

WAN Status	
Active IP	192.168.1.198
Current Netmask	255.255.255.0
Current Gateway	192.168.1.254
MAC Address	00:09:45:5a:9a:94
Get MAC Time	20110628
WAN Setting	
Static <input type="radio"/>	DHCP <input checked="" type="radio"/> PPPoE <input type="radio"/>
Auto DNS	<input checked="" type="checkbox"/>

Parameters:

- ✓ Active IP: IP phone's address.
- ✓ Current Net mask: network net mask.
- ✓ MAC Address: MAC of IP phone.
- ✓ Current Gateway: the IP address of the router.

B. If your ISP provide you with the fixed IP address, please choose static and fill in the correct information of IP Address、 Net mask、 Gateway、 Primary DNS etc. If you do not know it please refer to your ISP provider or network management stuff. The reference picture is as below.

Static <input checked="" type="radio"/>	DHCP <input type="radio"/>	PPPOE <input type="radio"/>
Auto DNS	<input checked="" type="checkbox"/>	
Static IP Address	<input type="text" value="192.168.1.179"/>	
Netmask	<input type="text" value="255.255.255.0"/>	
Gateway	<input type="text" value="192.168.1.1"/>	
DNS Domain	<input type="text"/>	
Primary DNS	<input type="text" value="202.96.134.133"/>	
Alter DNS	<input type="text" value="202.96.128.68"/>	

Parameters:

- ✓ Static IP Address: fixed IP address.
- ✓ Net mask: LAN net mask.
- ✓ Gateway: Gateway IP address.
- ✓ DNS Domain: input DNS domain name if it's provided.
- ✓ Primary DNS: Primary DNS address.
- ✓ Alter DNS: Alternative DNS address.

C、when you use PPPoE to get IP address, please select "PPPoE", and input ADSL account information as below picture:

Static <input type="radio"/>	DHCP <input type="radio"/>	PPPOE <input checked="" type="radio"/>
Auto DNS	<input checked="" type="checkbox"/>	
PPPOE Server	<input type="text" value="ANY"/>	
Username	<input type="text" value="sz38274340@163.gd"/>	
Password	<input type="password" value="....."/>	
<input type="button" value="APPLY"/>		

Parameters:

PPPoE Server: sever name, if the ITSP have no special requirements, please keep "ANY" as default.

Username: ADSL account username.

Password: ADSL account password.

Attention:

- 1) After configuration setting please click "Apply" to apply changes.
- 2) If the IP address is changed after effecting the configuration change , the webpage will lose response former address, so you must get to the webpage with new address.
- 3) If the LAN IP address is happened to be the same as WAN IP which is allocated from DHCP server. The LAN IP address will be changed automatically by adding 1 at the last digital.

2.2. LAN Config



IP Phone

[Current Status](#)
[Network](#)
[VOIP](#)
[Advanced](#)
[Dial-peer](#)
[Config Manage](#)
[Update](#)
[System Manage](#)

- [WAN Config](#)
- [LAN Config](#)

LAN Configuration

LAN Set	
LAN IP	<input type="text" value="192.168.10.1"/>
Netmask	<input type="text" value="255.255.255.0"/>
DHCP Service	<input checked="" type="checkbox"/>
NAT	<input checked="" type="checkbox"/>
Bridge Mode	<input type="checkbox"/>

Parameter:

- ✓ LAN IP: config LAN static IP.

- ✓ Net mask: LAN net mask.
- ✓ DHCP Service: enable LAN DHCP Server , need to reboot to make it available.
- ✓ NAT: Network Address Translation.
- ✓ Bridge Mode: Select Bridge Mode or not: If you select Bridge Mode, the phone will no longer set IP address for LAN physical port, LAN and WAN will join in the same network. Click "Apply", the phone will reboot.

3、 VoIP

3.1. SIP1/SIP2/SIP3/SIP4

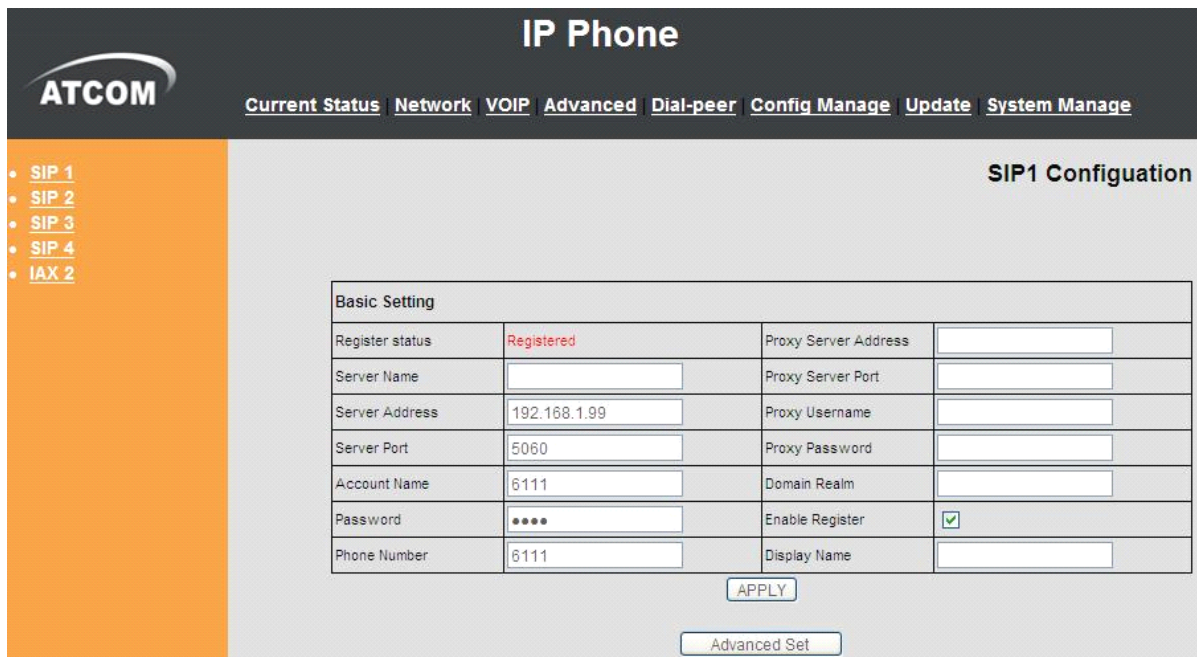

Basic Setting			
Register status	Registered	Proxy Server Address	<input type="text"/>
Server Name	<input type="text"/>	Proxy Server Port	<input type="text"/>
Server Address	192.168.1.99	Proxy Username	<input type="text"/>
Server Port	5060	Proxy Password	<input type="text"/>
Account Name	6111	Domain Realm	<input type="text"/>
Password	••••	Enable Register	<input checked="" type="checkbox"/>
Phone Number	6111	Display Name	<input type="text"/>

- ✓ Register Status: SIP server registration status, if succeed display Registered, or else display Unregistered.
- ✓ Server name: SIP server name , if no special requirements just keep it as blank.
- ✓ Server Address: SIP server address , support both IP address and domain name.
- ✓ Server Port: SIP server port , default is 5060.
- ✓ Account Name: SIP account name.
- ✓ Phone Number: SIP account phone number, if leave it as blank , no registration information will be sent out.
- ✓ Display Name: Show the display name that you want to display on the phone of callee. Support number and letter input.
- ✓ Proxy Server Address: Normally the Proxy server is the same as SIP server. If they are different then fill in the correct information that provided by ISP.
- Proxy Server Port: Set your SIP server port.
- Proxy Username: Input your SIP register account name.

- Proxy Password: Input your SIP register password.
- Domain Realm: config SIP local domain. If the server does not have special requirements for the local domain of SIP terminal, the local domain can be the same as SIP server domain. The user can also leave it as blank; the system will take SIP server domain as the domain realm.
- ✓ Enable Register: Enable or disable registration .

Advanced SIP setting

Advanced Set

Advanced SIP Setting			
Register Expire Time	60 <input type="text"/> seconds	Forward Type	Off <input type="button" value="v"/>
Auto Detect Server Interval	60 <input type="text"/> seconds	Forward Phone Number	<input type="text"/>
User Agent	Voip Phone 1.0 <input type="text"/>	Server Type	common <input type="button" value="v"/>
Signal Key	<input type="text"/>	DTMF Mode	DTMF_RFC2833 <input type="button" value="v"/>
Media Key	<input type="text"/>	RFC Protocol Edition	RFC3261 <input type="button" value="v"/>
Local Port	5060 <input type="text"/>	Transport Protocol	UDP <input type="button" value="v"/>
Hotline Number	<input type="text"/>	Subscribe Expire Time	300 <input type="text"/> seconds
MWI Number	<input type="text"/>	Conference Number	<input type="text"/>
Enable Keep Authentication	<input type="checkbox"/>	Signal Encode	<input type="checkbox"/>
Auto Detect Server	<input type="checkbox"/>	Rtp Encode	<input type="checkbox"/>
Enable Via rport	<input checked="" type="checkbox"/>	Enable Session Timer	<input type="checkbox"/>
Enable PRACK	<input type="checkbox"/>	Answer With Single Codec	<input type="checkbox"/>
Long Contact	<input type="checkbox"/>	Auto TCP	<input type="checkbox"/>
Click To Talk	<input type="checkbox"/>	Enable URI Convert	<input checked="" type="checkbox"/>
Ban Anonymous Call	<input type="checkbox"/>	Enable Displayname Quote	<input type="checkbox"/>
Dial Without Register	<input type="checkbox"/>	Enable GRUU	<input type="checkbox"/>
Enable Strict Proxy	<input type="checkbox"/>	Enable Subscribe	<input type="checkbox"/>
Enable Conference Num	<input type="checkbox"/>		

APPLY

- ✓ Register Expire Time: register expire time, default is 60 seconds. AT-640 will auto configure this expire time to the server recommended setting if it is different from the SIP server.
- ✓ Auto Detect Server Interval: Set examining interval of the server, default is 60 seconds.
- ✓ User Agent: Set the user agent if have, the default is VoIP Phone 1.0.
- ✓ Signal Key: Signal encryption Key.
- ✓ Media Key: voice stream encryption Key.
- ✓ Local Port: Local SIP signal port, default as 5060.
- ✓ Hotline Number: Set hot line number of each line.
- ✓ MWI Number: Set SIP1 voicemail Number.
- ✓ Enable Keep Authentication: Enable/Disable Keep Authentication System will take the last authentication field which is passed the authentication by server to

the request packet. It will decrease the server's repeat authorization work, if it is enable.

- ✓ Auto Detect Server: Enable/Disable keeps NAT of SIP alive. If some server refuse to register with too short interval time, and has no packets sending to device in private network to keep NAT alive, user could set this function ON. It need set the keep alive interval time less than the NAT server's.
- ✓ Enable Via rport: Enable/Disable system to support RFC3581. Via rport is special way to realize SIP NAT.
- ✓ Enable PRACK: Enable or disable SIP PRACK function, suggest use the default config.
- ✓ Long Contact: Set more parameters in contact field.
- ✓ Click to Talk: Set click to Talk (need practical software support).
- ✓ Ban Anonymous Call: Set to ban Anonymous Call.
- ✓ Dial Without Register: Set call out by proxy without registration.
- ✓ Enable Strict Proxy: Support the special SIP server-when phone receives the packets sent from server, phone will use the source IP address, not the address in via field.
- ✓ Enable Conference Num: conference ID.
- ✓ Forward Type: Select call forward mode, the default is Off .
 - Off: Close down calling forward.
 - Busy: If the phone is busy, incoming calls will be forwarded to the appointed phone.
 - No answer: If there is no answer, incoming calls will be forwarded to the appointed phone.
 - Always: Incoming calls will be forwarded to the appoint phone directly. The phone will prompt the incoming while doing forward.
- ✓ Forward Phone Number: Appoint your forward phone number.
- ✓ Server Type: Select the special type of server which is encrypted, or has some unique requirements or call flows.
- ✓ DTMF Mode: Select DTMF sending mode, there are three modes:
 - DTMF_RELAY
 - DTMF_RFC2833
 - DTMF_SIP_INFODifferent VoIP Service providers may provide different modes.
- ✓ RFC Protocol Edition: Select SIP protocol version to adapt for the SIP server which uses the same version as you select. For example, if the server is CISCO5300, you need to change to RFC2543; else phone may not cancel call normally. System uses RFC3261 as default.
- ✓ Transport Protocol: Set transport protocols, TCP or UDP.
- ✓ Subscribe Expire Time: Overtime of resending subscribe packet. Suggest using the default config.
- ✓ Conference Number: config certain Conference call number.
- ✓ Signal Encode: enable signal encryption.
- ✓ Rtp Encode: enable voice data encryption.

- ✓ Enable Session Timer: enable rfc4028 to refresh the SIP sessions.
- ✓ Answer With Single Codec: only answer the call with a certain Codec.
- ✓ Auto TCP: enable TCP transmission protocol when the length of message exceed 1300 byte.
- ✓ Enable URI Convert: convert # into %23 when sending URI.
- ✓ Enable Display name Quote: Set to make quotation mark to display name as the phone sends out signal, in order to be compatible with server.
- ✓ Enable GRUU: Set to support GRUU.
- ✓ Enable Subscribe: Enable Subscribe: Overtime of resending subscribe packet. Suggest using the default config.

3.2. Iax2 Config

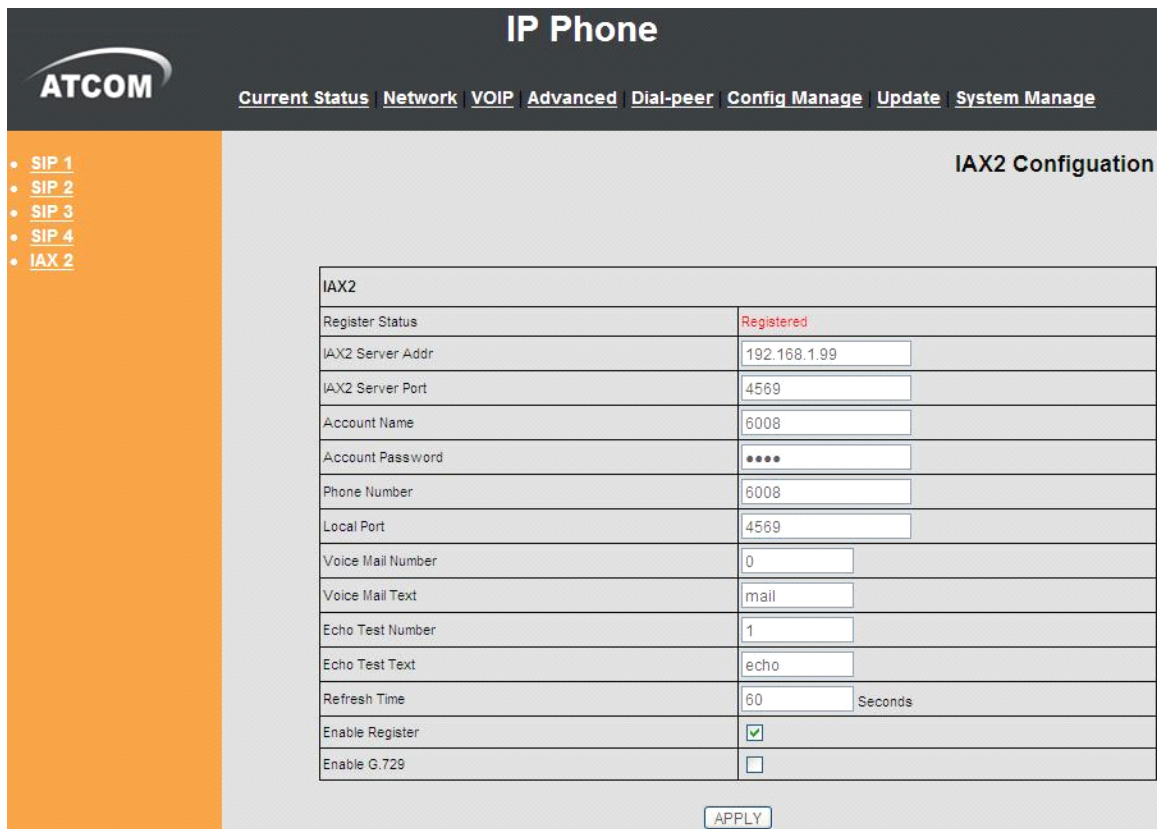

IAX2	
Register Status	Registered
IAX2 Server Addr	192.168.1.99
IAX2 Server Port	4569
Account Name	6008
Account Password	••••
Phone Number	6008
Local Port	4569
Voice Mail Number	0
Voice Mail Text	mail
Echo Test Number	1
Echo Test Text	echo
Refresh Time	60 Seconds
Enable Register	<input checked="" type="checkbox"/>
Enable G.729	<input type="checkbox"/>

APPLY

Above is the IAX server configuration page

- ✓ IAX Server Addr: Register address of public IAX server.
- ✓ IAX Server Port: Register port of public IAX server, default port is 4569.
- ✓ Account Name: Username of your SIP account (Always the same as the phone number).
- ✓ Account Password: Password of your IAX account.
- ✓ Local port: Signal port of local, default port is 4569.
- ✓ Phone Number: Phone number of your IAX account.
- ✓ Voice mail number: If the IAX support voice mail, but your username of the

voice mail is letters which you cannot input with the ATA , then you use the number to stand for your username.

- ✓ Voice mail text: if IAX support voice mail, config the domain name of your mail box here.
- ✓ Echo test number: If the platform support echo test , and the number is test form , the config the test number to replace the text format The echo test is to test the error status of terminals and platform.
- ✓ Echo test text: echo test number in text format.
- ✓ Refresh time: IAX refresh time.
- ✓ Enable Register: enable or disable register.
- ✓ Enable G.729: Using G.729 speech coding mandatory consultations.

4、 Advanced

4.1. DHCP Server

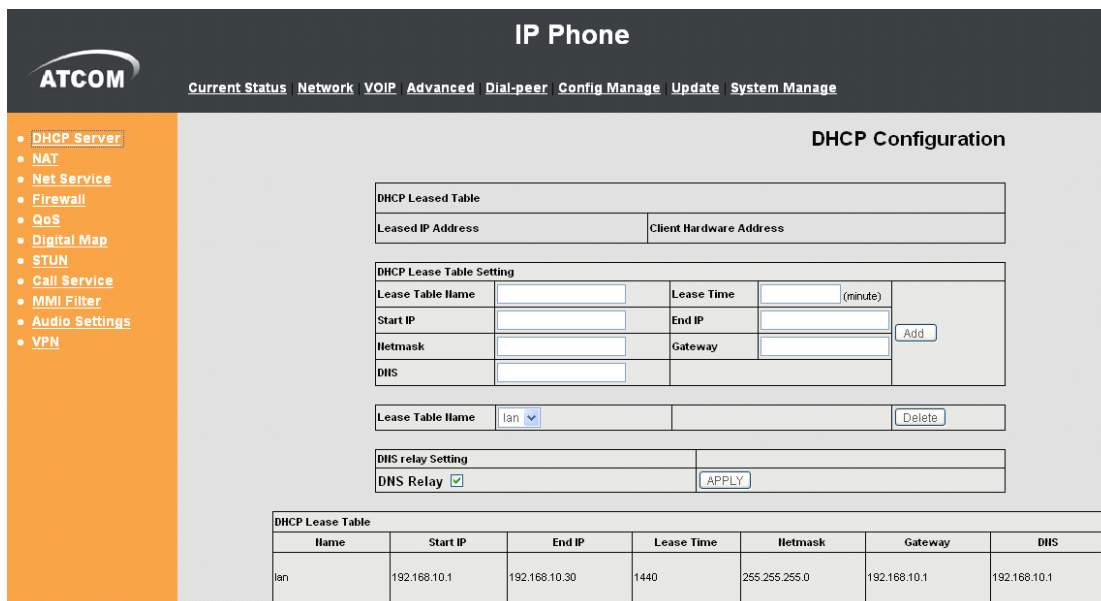

Name	Start IP	End IP	Lease Time	Netmask	Gateway	DNS
lan	192.168.10.1	192.168.10.30	1440	255.255.255.0	192.168.10.1	192.168.10.1

- ✓ DHCP Leased Table: IP-MAC mapping table. If the LAN port of the phone connects to a device, this table will show the IP and MAC address of this device.
 - ✓ Leased IP Address: the IP address which is assigned.
 - ✓ Client Hardware Address: the IP address assigned and the MAC opposite of IP.
- DHCP Lease Table Setting:
- ✓ Lease Table Name: Lease table name.
 - ✓ Lease Time: DHCP server lease time.
 - ✓ Start IP: Start IP of lease table.
 - ✓ End IP: End IP of lease table. Network device connecting to the AT640 LAN port can dynamic obtain the IP in the range between start IP and end IP.
 - ✓ Net mask: Net mask of lease table.
 - ✓ Gateway: Default gateway of lease table.

- ✓ DNS: default DNS server of lease table.
- ✓ Press "add" to apply, will added DHCP lease table.
- ✓ Lease Table Name: Select name of lease table, click the **Delete** button will delete the selected lease table from DHCP lease table.
- ✓ DNS Relay: Select DNS Relay, the default is enable. Click the Apply button to become effective.
- ✓ DHCP Lease Table: Shows the DHCP Lease Table, the unit of Lease time is Minute.

Notice:

- 1) The size of lease table cannot be larger than the quantity of C network IP address. We recommend you to use the default lease table and not modify it.
- 2) If you modifies the DHCP lease table, you need save the configuration and reboot.

4.2. NAT

NAT is abbreviated from Net Address Translation; it's a protocol responsible for IP address translation. In other word, it is responsible for transforming IP and port of private network to public, also is the IP address mapping which we usually say.

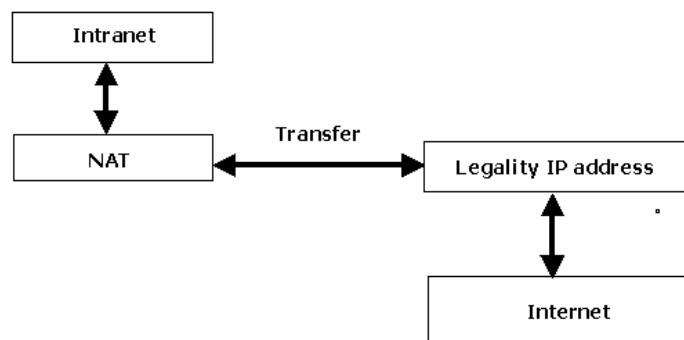

DMZ config:

In order to make some intranet equipments support better service for extranet, and make internal network security more effectively, these equipments open to extranet need be separated from the other equipments not open to extranet by the corresponding isolation method according to different demands. We can provide the different security level protection in terms of the different resources by building a DMZ region which can provide the network level protection for the equipments environment, reduce the risk which is caused by providing service to distrust customer, and is the best position to put public information The following chart describes the network access control of DMZ.

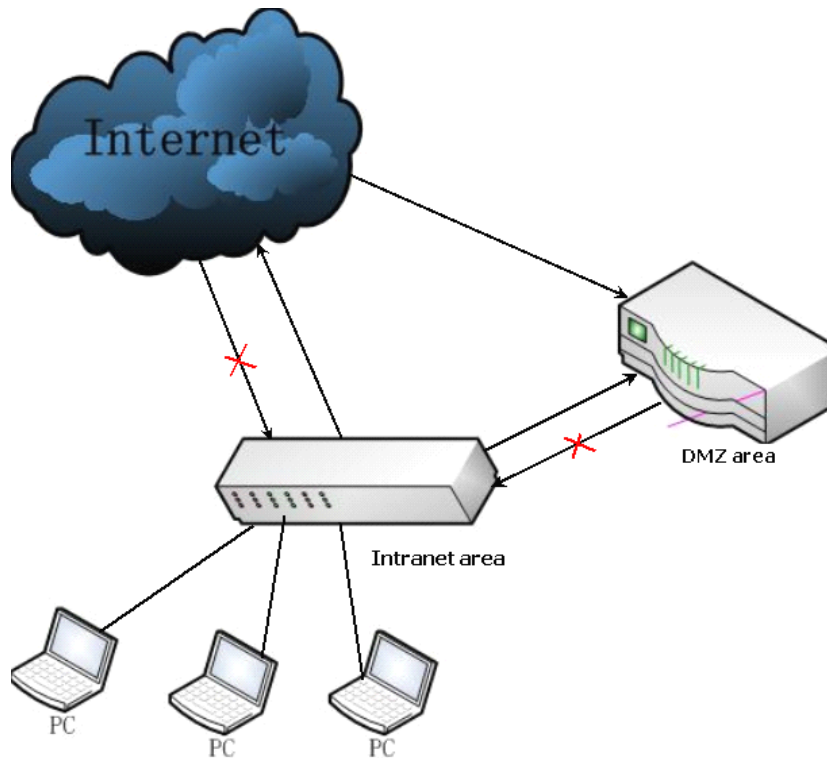

The setting page as below:

IP Phone

Current Status
Network
VOIP
Advanced
Dial-peer
Config Manage
Update
System Manage

- DHCP Server
- NAT
- Net Service
- Firewall
- QoS
- Digital Map
- STUN
- Call Service
- MMI Filter
- Audio Settings
- VPN

NAT Configuration

<input checked="" type="checkbox"/> IPsec ALG	<input checked="" type="checkbox"/> FTP ALG	<input checked="" type="checkbox"/> PPTP ALG
<input type="button" value="APPLY"/>		

NAT Table		
Inside IP	Inside TCP Port	Outside TCP Port
Inside IP	Inside UDP Port	Outside UDP Port

NAT Table Option			
Transfer Type	TCP	Outside Port	<input type="text"/>
Inside Ip	<input type="text"/>	Inside Port	<input type="text"/>
<input type="button" value="Add"/>		<input type="button" value="Delete"/>	

DMZ Table			
Outside IP		Inside IP	
Outside IP	<input type="text"/>	Inside IP	<input type="text"/>
Outside IP	<input type="text"/>	Inside IP	<input type="text"/>
			<input type="button" value="Add"/>
			<input type="button" value="Delete"/>

- ✓ IPsec ALG: It is an encryption technology. Select it to enable IPsec ALG, the default is enable.

- ✓ FTP ALG: FTP is a service of connection layer which can transform intranet IP into extranet IP when intranet IP is sending out packet. Select it to enable FTP ALG, the default is enabling.
- ✓ PPTP ALG: Select it enable PPTP ALG, the default is enable.

NAT Table		
Inside IP	Inside TCP Port	Outside TCP Port
192.168.20.11	645	456

Shows the NAT TCP mapping table

Inside IP	Inside UDP Port	Outside UDP Port
192.168.20.23	5002	5001

Shows the NAT UDP mapping table.

NAT Table Option:

- ✓ Transfer Type: Select the NAT mapping protocol style, TCP or UDP.
- ✓ Inside IP: Set the IP address of device which is connected to LAN interface to do NAT mapping.
- ✓ Inside Port: Set the LAN port of the NAT mapping.
- ✓ Outside Port: Set the WAN port of the NAT mapping.

Notice: After finish setting, click the Add button to add new mapping table. click the Delete button to delete the selected mapping table.

DMZ Config

DMZ Table			
Outside IP		Inside IP	
192.168.1.23		192.168.10.3	
Outside IP	<input type="text"/>	Inside IP	<input type="text"/>
Outside IP	192.168.1.23		<input type="button" value="Delete"/>

- ✓ DMZ Table: Shows the outside WAN port IP address and the inside LAN port IP address.
- ✓ Outside IP: Set the outside wan port IP address of DMZ.
- ✓ Inside IP: Set the inside LAN port IP address of DMZ.

Click the "Add" button to add new table; click the "Delete" button to delete the selected mapping table.

Notice: 10M/100M adaptive means the network card, and other equipment physical consultations speed, testing speed under bridge mode near to 100M, in order to ensure the quality of voice and communications real-time performance, we made some sacrifices of NAT under the transmission performance. Transmit with full capability only when system is idle, so cannot guarantee that the transmission speed reach to 100M.

4.3. Net Service

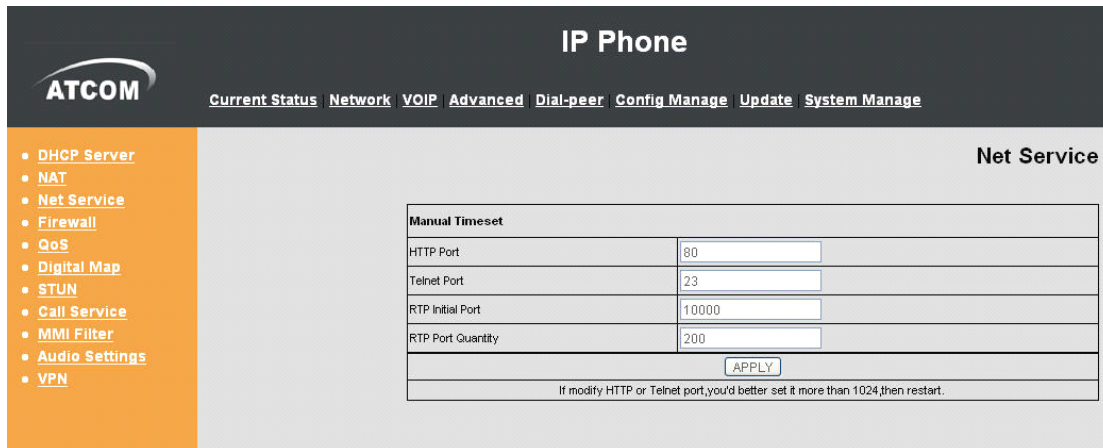

- ✓ HTTP Port: set web browser port, the default is 80 port, if you want to enhance system safety, you'd better change it into non-80 standard port; Example: The IP address is 192.168.10.88. and the port value is 6090, the accessing address is <http://192.168.10.88:6090>
- ✓ Telnet Port: Set Telnet Port, the default is 23. You can change the value into others. Example: The IP address is 192.168.1.88. the telnet port value is 6023, the accessing address is telnet 192.168.1.88:6023
- ✓ RTP Initial Port: Set the RTP Initial Port. It is dynamic allocation.
- ✓ RTP Port Quantity: Set the maximum quantity of RTP Port, the default is 200.

Notice:

- 1) You need save the configuration and reboot the phone after set this page.
- 2) If you modify the port of Telnet and HTTP, you would better set the value more than 1024 because the port value less than 1024 is system port reserved.
- 3) if you set 0 for the HTTP port, it will disable HTTP service.

4.4. Firewall



- ✓ in_access enable: Select it to Enable in_ access rule.

- ✓ out_access enable: Select it to Enable out_access rule.
- ✓ Firewall Input Rule Table: Firewall input rule, as the picture config is deny 192.168.1.2 ping 192.168.10.2, but ping 192.168.10.0/24 beside 192.168.10.3 is ok.
- ✓ Firewall Output Rule Table: Firewall output rule, as the picture config is the phone ping 192.168.1.70 was deny.

Input/Output <input type="text" value="Input"/>	Deny/Permit <input type="text" value="Deny"/>
Protocol Type <input type="text" value="UDP"/>	Port Range <input type="text" value="more than"/>
Src Addr <input type="text"/>	Des Addr <input type="text"/>
Src Mask <input type="text"/>	Des Mask <input type="text"/>
<input type="button" value="Add"/>	

Input/Output <input type="text" value="Input"/>	Index to be deleted <input type="text"/>
<input type="button" value="Delete"/>	

- ✓ Input/output: Specify current adding rule by selecting input rule or output rule.
- ✓ Deny/Permit: Specify current adding rule by selecting Deny rule or Permit rule.
- ✓ Protocol Type: Filter protocol type. You can select TCP, UDP, ICMP, or IP.
- ✓ Port Range: Set the filter Port range.
- ✓ Src Addr: Set source address. It can be single IP address, network address, complete address 0.0.0.0, or network address similar to *.*.*.0.
- ✓ Dest Addr: Set the destination address. It can be IP address, network address, complete address 0.0.0.0, or network address similar to *.*.*.*.
- ✓ Src Mask: Set the source address' mask. For example, 255.255.255.255 means just point to one host; 255.255.255.0 means point to a network which network ID is C type.
- ✓ Des Mask: Set the destination address' mask. For example, 255.255.255.255 means just point to one host; if set to 255.255.255.0 means point to a network which network ID is C type.

4.5. Qos

IP Phone

Current Status
Network
VOIP
Advanced
Dial-peer
Config Manage
Update
System Manage

- DHCP Server
- NAT
- Net Service
- Firewall
- **QoS**
- Digital Map
- STUN
- Call Service
- MMI Filter
- Audio Settings
- VPN

QoS Configuration

<input type="checkbox"/> VLAN Enable			
<input checked="" type="checkbox"/> VLAN ID Check Enable	Voice/Data VLAN differentiated	<input type="text" value="Undifferentiated"/>	
<input type="checkbox"/> DiffServ Enable	DiffServ Value	<input type="text" value="0x b8"/>	
Voice VLAN ID	<input type="text" value="256"/> (0 - 4095)	Data VLAN ID	<input type="text" value="254"/> (0 - 4095)
Voice 802.1P Priority	<input type="text" value="0"/> (0 - 7)	Data 802.1P Priority	<input type="text" value="0"/> (0 - 7)

- ✓ VLAN Enable: Before select it to enable VLAN, you need enable Bridge mode in LAN config.
- ✓ VLAN ID Check Enable: Enable VLAN ID check by selecting it. After enable VLAN ID check, if VLAN ID of a data package is not the same with the phone's or a data package do not have VLAN ID, the data package will be discarded.
- ✓ Voice/Data VLAN differentiated: After enable VLAN, system will set packets with different type of VLAN ID. Undifferentiated means after using VLAN, both voip packets and other data packets will use the voice VLAN ID; tag differentiated means after using VLAN, VoIP(signal and voice) packets will add voice VLAN ID, and other data packets will add data VLAN ID; data untagged means after using VLAN, only VoIP packets will add voice VLAN ID. Other data packets will not use VLAN.
- ✓ DiffServ Enable: Select it or not to Enable or disable DiffServ.
- ✓ DiffServ Value: Set DiffServ value, the common value is 0x00.
- ✓ Voice 802.1P Priority: Specify 802.1P Priority of voice/signal data package.
- ✓ Data 802.1P Priority: Set 802.1p of data VLAN. Non-voip data (such as http, telnet, ping etc) will use this value to set VLAN package.
- ✓ Voice VLAN ID: Set VLAN ID of voice/signal data package.
- ✓ Data VLAN ID: Set 802.1q of data VLAN ID. Non-VoIP data (such as http, telnet, ping etc) will use this value to set VLAN package.

Notice:

- 1) Enable VLAN, if set Voice and Data VLAN differentiated as Undifferentiated, all packets will use the Voice VLAN ID as the tag.
- 2) Enable VLAN, if set Voice and Data VLAN differentiated as tag differentiated and disable the DiffServ, then system will not distinguish the voice and data, all packets will use the Voice VLAN ID as the tag.
 - 3) Enable VLAN, if set Voice and Data VLAN differentiated as tag differentiated and enable the DiffServ, then system will distinguish the voice and data and add the VLAN ID each other.
 - 4) Enable VLAN, if set Voice and Data VLAN differentiated as date untagged, then the packet of the signal and voice will use the voice VLAN ID as the tag, but the data packets will not take the VLAN tag.
- 5,if disable the VLAN, regardless to set the voice and data VLAN differentiated or not, all packets will not take the VLAN tag; if enable the DiffServ, all packets will only take the DiffServ value.
- 6) One must to notice, enable the VLAN ID check enable that is default, if enable
 - Must to notice, VLAN ID check Enable feature is default enable, if enable it, The phone will match the VLAN ID strictly, When others' VLAN ID mismatch with IP Phone, the packets will discard, Contrarily, the phone will accept the packets with the distinct VLAN ID.
 - You must set the IP with static mode when you set VLAN, otherwise can't obtain the IP in the VLAN and also cannot dial with point to point

4.6. Digital Map

IP Phone

Current Status
Network
VOIP
Advanced
Dial-peer
Config Manage
Update
System Manage

- DHCP Server
- NAT
- Net Service
- Firewall
- QoS
- Digital Map
- STUN
- Call Service
- MMI Filter
- Audio Settings
- VPN

Digital Map

Digital Map Set	
<input checked="" type="checkbox"/>	End with "#"
<input type="checkbox"/>	Fixed Length 11
<input checked="" type="checkbox"/>	Time out 5 (3-30)

Digital Rule table
Rules:
"1-8]xxx"
"9xxxxxxx"
"911"
"88T4"
"6611x.T4"
<input style="width: 80%; border: none;" type="text"/> <input type="button" value="Add"/> 1-8]xxx <input type="button" value="Del"/>

Digit map is a set of rules to determine when the user has finished dialing.

AT640 support below digital map:

- ✓ End With "#": Use # as the end of dialing.
- ✓ Fixed Length: The call will be sent out automatically when the length of the number you dial reaches the fixed one. For example if you set number of 11 here, when you dial 11 digits the call will be sent out immediately.
- ✓ Timeout: Specify the timeout of the last dial digit. The call will be sent after timeout.
- ✓ Prefix: User define digital map:
 - [] represents the range of digit, can be a range such as [1-4], or use comma such as [1,3,5], or use a list such as [234]
 - x represents any one digit between 0~9
 - Tn represents the last digit timeout. n represents the time from 0~9 second, it is necessary. Tn must be the last two digit in the entry. If Tn is not included in the entry, we use T0 as default, it means system will sent the number immediately if the number matches the entry.
- ✓ Example:
 - [1-8]xxx All number from 1000 to 89999 will be sent immediately.
 - 9xxxxxxx 8 digits numbers begin with 9 will be sent immediately.
 - 911 Number 911 will be sent will be immediately.
 - 88xT4 3 digits numbers begin with 88with be sent after 4s.
 - 6611x.T4 holds four seconds send out if the number begins 6611 and five digits.

Notice: The above configuration can exist at the same time. For example you enable # as the signal of sending the call while set fixed length of 11. Either you press # before the number reach 11 or dial 11 digital can send out the call.

4.7. Stun

IP Phone

Current Status
Network
VOIP
Advanced
Dial-peer
Config Manage
Update
System Manage

- DHCP Server
- NAT
- Net Service
- Firewall
- QoS
- Digital Map
- STUN
- Call Service
- MMI Filter
- Audio Settings
- VPN

Stun Configuration

STUN Set	
STUN NAT Transverse	TRUE
STUN Server Addr	<input type="text" value="stun.xten.com"/>
STUN Server Port	<input type="text" value="3478"/>
STUN Effect Time	<input type="text" value="50"/> Seconds
Local SIP Port	<input type="text" value="5060"/>
Use Stun	<input checked="" type="checkbox"/>

- ✓ STUN NAT Transverse: STUN NAT Transverse status true or false.
- ✓ STUN Server Addr: configure stun server address.
- ✓ STUN Server Port: configure stun server port default 3478.
- ✓ STUN Effect Time: stun detect NAT type interval time .If NAT found a link inactive for a certain time , it will close the link so you need to send a packet within a interval tome to keep the link alive.
- ✓ Local SIP Port: config local SIP port , default as 5060Use Stun: enable/disable SIP STUN.

Attention:

SIP STUN is used for NAT transverse. When you config STUN server's address and port (default 3478) and enable it, then you can use the normal SIP server to make the IP phone transverse NAT.

4.8. Call Service

IP Phone

ATCOM

[Current Status](#)
[Network](#)
[VOIP](#)
[Advanced](#)
[Dial-peer](#)
[Config Manage](#)
[Update](#)
[System Manage](#)

• DHCP Server
• NAT
• Net Service
• Firewall
• QoS
• Digital Map
• STUN
• Call Service
• MMI Filter
• Audio Settings
• VPN

Call Service Setting

No Answer Time	20 (seconds)	P2P IP Prefix	
No Disturb	<input type="checkbox"/>	Ban Outgoing	<input type="checkbox"/>
Enable Call Transfer	<input checked="" type="checkbox"/>	Enable Call Waiting	<input checked="" type="checkbox"/>
Auto Answer	<input type="checkbox"/>	Accept Any Call	<input checked="" type="checkbox"/>
Enable Three Way Call	<input checked="" type="checkbox"/>		

Black List

<input type="text"/>	<input type="button" value="Add"/>	<input type="button" value="▼"/>	<input type="button" value="Delete"/>
----------------------	------------------------------------	----------------------------------	---------------------------------------

Limit List

<input type="text"/>	<input type="button" value="Add"/>	<input type="button" value="▼"/>	<input type="button" value="Delete"/>
----------------------	------------------------------------	----------------------------------	---------------------------------------

- ✓ No Answer Time: no answer call forward time setting.
- ✓ No Disturb: DND, do not disturb, when there is an incoming call , the caller will get the message that this line is not available , but you it has no affection when you make outgoing call.
- ✓ Ban Outgoing: Enable this to ban outgoing calls.
- ✓ Enable Call Transfer: Enable Call Transfer by selecting it.
- ✓ Enable Call Waiting: Enable Call Waiting by selecting it.
- ✓ Enable Three Way Call: 3 way conference call.
- ✓ Accept Any Call:If select it, the phone will accept the call even if the called number is not belong to the phone.
- ✓ Auto Answer:If select it, the phone will auto answer when there is an incoming call.
- ✓ P2P IP Prefix: Set Prefix in peer to peer IP call. For example: what you want to dial is 192.168.1.119, If you define P2P IP Prefix as 192.168.1., you dial only #119 to reach 192.168.1.119. Default is ".". If there is no "." Set, it means to disable dialing IP.
- ✓ Black List: Set Add/Delete Black list, incoming call in these phone numbers will be refused.
It support below rules:
 - You add a certain number in it , when this number call you , it will be refused.
 - Use "x" to represent any number. For example , 4xx means any incoming call with 3 digital and the first digital is 4 , will be refused.
 - DOT (.) means matching any arbitrary number digit. for example, any number with prefix 6 will be forbidden to dialed out. Any digital call with a certain head number, For example **6.** means any incoming number with the 6 as the first number will be refused.
 - if user wants to allow a number or a series of number incoming, he may add

the number(s) to the list as the white list rule. the configuration rule is -number, for the settings as below.

Black List			
-7049			
<input type="text"/>	<input type="button" value="Add"/>	-7049 ▼	<input type="button" value="Delete"/>

-7049 means any incoming number is forbidden except 7049

Notice: End with DOT (.) when set up the white list

- ✓ Limit List: Set Add/Delete Limit List. Please input the prefix of those phone numbers which you forbid the phone to dial out. For example, if you want to forbid those phones of 001 as prefix to be dialed out, you need input 001 in the blank of limit list, and then you cannot dial out any phone number whose prefix is 001. x and . are wildcard. x means matching any single digit. for example, 4xxx expresses any number with prefix 4 which length is 4 will be forbidden to dialed out . Means matching any arbitrary number digit. For example, 6. expresses any number with prefix 6 will be forbidden to dialed out.

4.9. MMI Filter

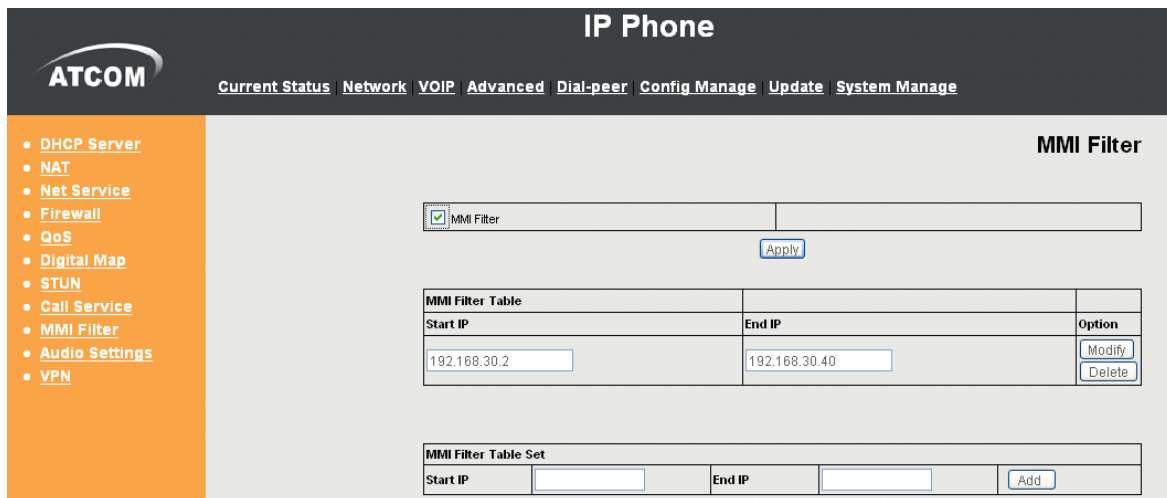

The screenshot shows the 'IP Phone' configuration interface with a sidebar menu on the left containing items like DHCP Server, NAT, Net Service, Firewall, QoS, Digital Map, STUN, Call Service, MMI Filter, Audio Settings, and VPN. The main content area is titled 'MMI Filter' and includes a checkbox for 'MMI Filter' with an 'Apply' button. Below this is an 'MMI Filter Table' with columns for 'Start IP', 'End IP', and 'Option'. A single entry is shown with 'Start IP' 192.168.30.2 and 'End IP' 192.168.30.40, with 'Modify' and 'Delete' buttons. At the bottom, there is an 'MMI Filter Table Set' section with 'Start IP' and 'End IP' input fields and an 'Add' button.

User could make some device own IP, which is pre-specified, access to the MMI of the phone to config and manage the phone.

Add or delete the IP address segments that access to the phone. Set initial IP address in the Start IP column, Set end IP address in the End IP column, and click Add to add this IP segment. You can also click Delete to delete the selected IP segment.

Notice: Do not set your visiting IP outside the MMI filter range, otherwise, you cannot logon through the web.

4.10.Audio Settings



IP Phone

[Current Status](#)
[Network](#)
[VOIP](#)
[Advanced](#)
[Dial-peer](#)
[Config Manage](#)
[Update](#)
[System Manage](#)

- [DHCP Server](#)
- [NAT](#)
- [Net Service](#)
- [Firewall](#)
- [QoS](#)
- [Digital Map](#)
- [STUN](#)
- [Call Service](#)
- [MMI Filter](#)
- [Audio Settings](#)
- [VPN](#)

Audio Settings

DSP Configuration			
First Codec	g711Ulaw64k	Second Codec	g711Alaw64k
Third Codec	g729	Fourth Codec	g723
Fifth Codec	g726-32	Sixth Codec	g722
Input Volume	3 (1-9)	Output Volume	5 (1-9)
Handfree Volume	9 (1-9)	Ring Volume	4 (1-9)
G729 Payload Length	20ms	Signal Standard	China
G722 Timestamps	160/20ms	G723 Bit Rate	6.3kb/s
Default Ring Type	Type 1	VAD	<input type="checkbox"/>
Handdown Time	200 ms		

- ✓ First Codec: The first preferential DSP codec:G.711A/u, G722, G.723, G.726-32, G.729.
- ✓ Second Codec: The second preferential DSP codec:G.711A/u, G722, G.723, G.726-32, G.729.
- ✓ Third Codec : The third preferential DSP codec:G.711A/u, G722, G.723, G.726-32, G.729.
- ✓ Forth Codec: The Forth preferential DSP codec:G.711A/u, G722, G.723, G.726-32, G.729.
- ✓ Fifth Codec: The fifth preferential DSP codec:G.711A/u, G722, G.723, G.726-32, G.729.
- ✓ Sixth Codec: The sixth preferential DSP codec:G.711A/u, G722, G.723, G.726-32, G.729.
- ✓ Input Volume: Specify Input (MIC) Volume grade.
- ✓ Output Volume: Specify Output (receiver) Volume grade.
- ✓ Hands free Volume: Specify Hands free Volume grade.
- ✓ Ring Volume: Specify Ring Volume grade .
- ✓ G729 Payload Length: Set G729 Payload Length.
- ✓ Signal Standard: Select Signal Standard.
- ✓ G722 Timestamps: 160/20ms or 320/20ms is available.
- ✓ G723 Bit Rate: 5.3kb/s or 6.3kb/s is available.
- ✓ Default Ring Type: Select signal standard.
- ✓ VAD: Select it or not to enable or disable VAD. If enable VAD, G729 Payload length could not be set over 20ms.
- ✓ Handdown Time: Set the time which the phone hang up automatically after call ended when use handfree mode.

4.11.VPN



IP Phone

[Current Status](#)
[Network](#)
[VOIP](#)
[Advanced](#)
[Dial-peer](#)
[Config Manage](#)
[Update](#)
[System Manage](#)

- [DHCP Server](#)
- [NAT](#)
- [Net Service](#)
- [Firewall](#)
- [QoS](#)
- [Digital Map](#)
- [STUN](#)
- [Call Service](#)
- [MMI Filter](#)
- [Audio Settings](#)
- [VPN](#)

VPN Tunnel

VPN IP	192.168.0.2		
L2TP			
VPN Server Addr	192.168.1.250	VPN User Name	user
VPN Password	••••••••		

<input checked="" type="checkbox"/> L2TP	<input checked="" type="checkbox"/> Enable VPN		

this page is VPN setting page , the IP phone support the VPN with UDP and L2TP protocol .The parameters is as below.

- ✓ VPN IP: After VPN registered successfully, VPN server will give an IP address to the terminal. If there is a IP address shown on terminal (except for 0.0.0.0), it means your VPN has registered.
- L2TP
- ✓ VPN Server Addr: Register to the address of VPN server
- ✓ VPN User Name: L2TP VPN username
- ✓ VPN Password: L2TP VPN password
- ✓ L2TP: use the L2TP to visit VPN
- ✓ Enable VPN: Enable the VPN server, you must choose UDP or L2TP type in advance

5、 Dial Peer

IP Phone

[Current Status](#) | [Network](#) | [VOIP](#) | [Advanced](#) | [Dial-peer](#) | [Config Manage](#) | [Update](#) | [System Manage](#)

Dial-Peer

Dial Peer Table						
Number	Destination	Port	Mode	Alias	Suffix	Del length
2T	0.0.0.0	4569	IAX2	del	no suffix	1
33	0.0.0.0	5060	SIP	all:83018618	no suffix	0
0T	0.0.0.0	5060	SIP	rep:86	no suffix	1
179	192.168.1.179	5060	SIP	no alias	no suffix	0

This functionality offers you more flexible dial rule, you can refer to the following content to know how to use this dial rule. When you want to dial an IP address, the entry of IP addresses is very cumbersome, but by this functionality, you can set number 179 to replace 192.168.1.179 here.

When you want to dial a long distance call to China, you need dial an country code 86 before local phone number, but you can also dial number 0 instead of 86 after we make a setting according to this dial rule. For example, you want to dial 8675583018619, but you need dial only 075583018619 to realize your long distance call after you make this setting.

AT640 provide flexible dial rule, with different dial-rule configure, user can easily implement the following function:

- Replace, delete or add prefix of the dial number
- Make direct IP to IP call
- Place the call to different servers according the prefix

You can click "Add" to add a new dial rule. Below is the detail setting of the dial-rule:

Add Dial Peer	
Phone Number	<input type="text" value="8T"/>
Destination (optional)	<input type="text"/>
Port(optional)	<input type="text"/>
Alias(optional)	<input type="text" value="add:0755"/>
Call Mode	SIP <input type="button" value="v"/>
Suffix(optional)	<input type="text"/>
Delete Length (optional)	<input type="text"/>
<input type="button" value="Submit"/>	
Dial Peer Option	
<input type="button" value="2T"/> <input type="button" value="v"/>	<input type="button" value="Delete"/> <input type="button" value="Modify"/>

- ✓ Phone Number: The Number suit for this dial rule, can be set as full match or prefix match. Full match means that if the number user dialed is completely the same as this number, the call will use this dial-rule. Prefix match means that if prefix of the number that the user dials is the same as the prefix, the call will use this dial-rule, to distinguish from the full match case, you need to add "T" after the prefix number in the phone number setting.
- ✓ Call Mode: support SIP.
- ✓ Destination (optional): call destination, can be IP or domain. Default is 0.0.0.0; in this case the call will be routed to the Public SIP server. If you set the destination to 255.255.255.255, then the call will be routed to the private SIP server. Also you can key other address here to make direct IP calls.
- ✓ Port (optional): Configure the port of the destination, default is 5060 in SIP
- ✓ Alias (optional): Set up the Alias. We support four Alias as below. Alias need to co-work with the *Del Length*.
 - add:xxx, add prefix to the phone number, can set to reduce the dial length.
 - all: xxx, replace the phone number with the xxx, can use as speed dial function.
 - Del, delete the first N numbers. N is set in the *Del Length*.
 - rep:xxx, replace the first N numbers. N is set in the Del Length. For Example: Use wants to place a call 8610-62281493, then you can set the *phone number* in the dial rule as 010T, and set the *Alias* as rep:8610, and set the *Del Length* to 3. Then all calls begin with 010 will be changed to 8610 xxxxxxxx.
- ✓ Suffix (optional): Configure suffix, show no suffix if not set.

Instance description as picture:

- 2T rule: if the call starts with 2, the first 2 will be deleted, and the rest number with be sent to IAX2 Server.
- 33 rule: Dial 33 and will send 83018618 to your server. Used as speed dial function.
- 0T rule: If the calls are begin with 0, the first 0 will be replacing by 86. Mean that if you dial 075583018049 and AT640 will send 8675583018049 to your server.
- 179 rule: when you dial 179, the call with send to 192.168.1.179, suit for LAN application without set up a sip server.

You can also Modify and Delete the existed Dial Peer.

6、 Config Manage



- ✓ Save Config: you can save all changes of configurations. Click the Save button, all changes of configuration will be saved, and be effective immediately.
- ✓ Backup Config: Right clicks on "Right click here..." and select "Save Target As..." then you will save the config file in .txt format .
- ✓ Clear Config: user can restore factory default configuration and reboot the phone. If you login as Admin, the phone will reset all configurations and restore factory default; if you login as Guest, the phone will reset all configurations except for VoIP accounts (SIP1、 SIP2 and IAX2) and version number.

7、 Update

7.1. Web Update



Click the browse button, find out the config file saved before or provided by manufacturer, download it to the phone directly, press "Update" to save. You can

also update downloaded update file, logo picture, ring, mmiset file by web.

7.2. FTP/TFTP Update



Server	<input type="text"/>
Username	<input type="text"/>
Password	<input type="text"/>
File name	<input type="text"/>
Type	Application update
Protocol	FTP

- ✓ Server: FTP/TFTP server address. It can be the format of IP address such as 192.168.1.1 or domain such as ftp.domain.com. Meanwhile, it supports sub directories such as 192.168.1.1/ftp/config/ or ftp.domain.com/ftp/config.
- ✓ Username: FTP user name (TFTP no need).
- ✓ Password: FTP password (TFTP no need).
- ✓ File name: the firmware or configuration file name that IP phone will search for in the server. If left blank, the IP phone will search for the file with the name of its MAC such as 000102030405.

Notice: Users can revise the exported config file by themselves and import the config file with only modules, for example if there is the SIP setting page in the config file, the IP phone will only change SIP settings after importing this file and leave other settings as not changed.

- ✓ Type: upgrading type
 - Application update: update firmware.
 - Config file export: export the current configuration to a FTP/TFTP server.
 - Config file import: import configuration file from a FTP/TFTP server.
 - Protocol: choose server type FTP or TFTP.

7.3. Auto Provisioning

IP Phone

Current Status
Network
VOIP
Advanced
Dial-peer
Config Manage
Update
System Manage

- [Web Update](#)
- [FTP/TFTP Update](#)
- [Auto Provisioning](#)

Auto Provisioning

Auto Update Setting	
Current Version	2.0002
Server Address	<input type="text" value="0.0.0.0"/>
Username	<input type="text" value="user"/>
Password	<input type="password" value="****"/>
Config File Name	<input type="text"/>
Config Encrypt Key	<input type="text"/>
Protocol Type	<input type="text" value="FTP"/>
Update Interval Time	<input type="text" value="1"/> Hour
Update Mode	<input type="text" value="Disable"/>

- ✓ Current Version: the system will display the current version number. need to modify the version number in config file bigger than this number before auto provision update.
- ✓ Server Address: FTP/TFTP server address.
- ✓ Username: FTP server user name.
- ✓ Password: FTP server password.
- ✓ Config File Name: The name of configuration file. Normally users leave it as blank the IP phone search for the file with the name same as its MAC in the server.
- ✓ Config Encrypt Key: The encrypt key of confirmation file.
- ✓ Protocol Type: The protocol type that used for upgrading.:FTP,TFTP or Http.
- ✓ Update Interval Time: The interval time that the terminals search for new configuration file , counted in hour.
- ✓ Update Mode: auto provision mode;
 - A、Disable: not auto update,
 - B、Update after reboot: auto update after reboot,
 - C、Update at time interval: auto update after a certain time

8、 System Manage

8.1. Account Manage

IP Phone

[Current Status](#) | [Network](#) | [VOIP](#) | [Advanced](#) | [Dial-peer](#) | [Config Manage](#) | [Update](#) | [System Manage](#)

- [Account Manage](#)
- [Phone Book](#)
- [Multi Line Set](#)
- [Function Key Set](#)
- [Syslog Config](#)
- [Time Set](#)
- [Call Log](#)
- [Language Set](#)
- [Logout](#)
- [Reboot](#)

Account Manage

Set Menu Password

Menu password	...
---------------	-----

Set Keyboard Lock

Keyboard Lock password	...
Enable Keyboard Lock	<input type="checkbox"/>

Users can add new account or delete and change existing account

Set Menu Password: Set menu of keypad password, default is "123"

Set KeyboardLock: The default password is "123". It will take effect when you enable the keyboard lock. The default setting is unlock, if you press any key at this status, the system will remind you to input password

Set Backlight Timeout

Backlight Timeout	30
-------------------	----

Set Greeting Message

Greeting Message	VOIP PHONE
------------------	------------

User Set	
User Name	User Level
admin	Root
guest	General

Add User	
User name	<input type="text"/>
User level	Root <input type="button" value="v"/>
Password	<input type="text"/>
Confirm	<input type="text"/>

Account Option	
admin <input type="button" value="v"/>	<input type="button" value="Delete"/> <input type="button" value="Modify"/>

Set Backlight Timeout: Set backlight time out, if IP Phone has not press any operation to active within the settings value, the backlight will off.

Set Greeting Message: set the Greeting message on the LCD, default is VOIP PHONE.

- ✓ User Name: set new account name
- ✓ User Level: set new account level; root can read and change setting, general can only read
- ✓ Password: config password for new account
- ✓ Confirm: double confirm password

If you want to make change on existing account , select the account an click **【 Modify 】** or **【 Delete 】** . General account can only modify or delete general account

- ✓ Keyboard Password: config password that you use keyboard to access the menu , must be in number.

8.2. Phone Book

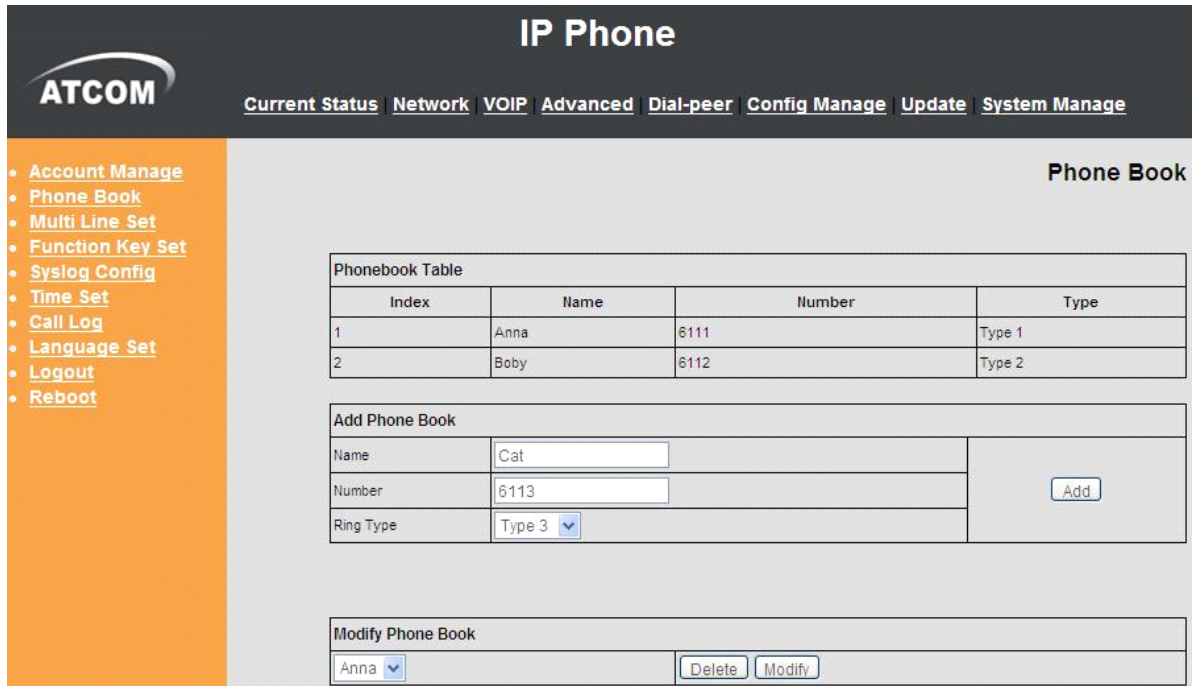

IP Phone

Current Status | Network | VOIP | Advanced | Dial-peer | Config Manage | Update | System Manage

Phone Book

Account Manage
Phone Book
Multi Line Set
Function Key Set
Syslog Config
Time Set
Call Log
Language Set
Logout
Reboot

Phonebook Table			
Index	Name	Number	Type
1	Anna	6111	Type 1
2	Bobby	6112	Type 2

Add Phone Book

Name	<input type="text" value="Cat"/>	<input type="button" value="Add"/>
Number	<input type="text" value="6113"/>	
Ring Type	<input type="text" value="Type 3"/>	

Modify Phone Book

<input type="text" value="Anna"/>	<input type="button" value="Delete"/>	<input type="button" value="Modify"/>
-----------------------------------	---------------------------------------	---------------------------------------

- ✓ Phonebook Table: shows phonebook detailed information
- ✓ Add Phone Book: add a new record in phonebook
- ✓ Name: nick name of a number , when the call of this number comes in the LCD will show the name
- ✓ Number: phone number
- ✓ Ring Type: set different ring for different person

If you want to make change on existing account , select the account and click **Modify** or **Delete** . General account can only modify or delete general account

Notice: Maximum records of phone book is 500pcs

8.3. Multi Line Set

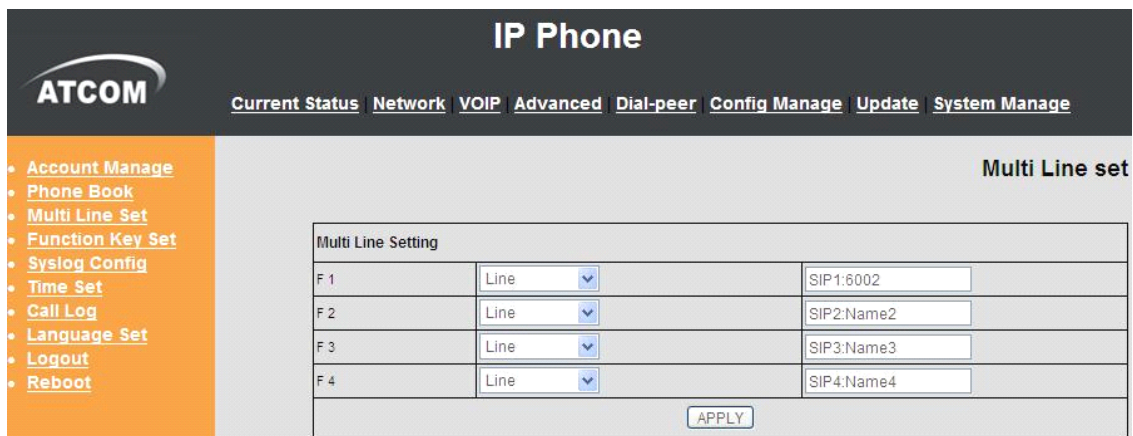

IP Phone

Current Status | Network | VOIP | Advanced | Dial-peer | Config Manage | Update | System Manage

Multi Line set

Account Manage
Phone Book
Multi Line Set
Function Key Set
Syslog Config
Time Set
Call Log
Language Set
Logout
Reboot

Multi Line Setting		
F 1	<input type="text" value="Line"/>	<input type="text" value="SIP1:6002"/>
F 2	<input type="text" value="Line"/>	<input type="text" value="SIP2:Name2"/>
F 3	<input type="text" value="Line"/>	<input type="text" value="SIP3:Name3"/>
F 4	<input type="text" value="Line"/>	<input type="text" value="SIP4:Name4"/>

Multi line function is one of SIP line is busy, but other lines can get the call when have new calls with the line.

The settings as below:

- 1, go to System Manage Multi Line set page,
- 2, set the F1/F2/F3/F4 to Multiple line and set the same SIP:name, such as SIP1:8047 or SIP2:8047 or IAX2:6008

The flow as below:

- 1,A call AT640 as 8047 and calling.
- 2,B call AT640 as 8047
- 3,LED of Line 2 is flicker
- 4,press Line2 or answer of softkey can call from B.

The one of 4 lines can also be configured as IAX2 line

- 1.Choose line (for example line2) ,set F2 to Line
- 2.Set SIP2:name as IAX2:name

8.4. Function Key Set

IP Phone

Current Status
Network
VOIP
Advanced
Dial-peer
Config Manage
Update
System Manage

- Account Manage
- Phone Book
- Multi Line Set
- **Function Key Set**
- Syslog Config
- Time Set
- Call Log
- Language Set
- Logout
- Reboot

Functionkeyset

Function Key Setting		
M1	Memory Key <input type="button" value="v"/>	<input type="text" value="6005@1/b"/>
M2	Line <input type="button" value="v"/>	<input type="text" value="IAX2"/>
M3	Key Event <input type="button" value="v"/>	<input type="text" value="F_A_TRANSFER"/>
M4	Key Event <input type="button" value="v"/>	<input type="text" value="F_DND"/>
M5	Key Event <input type="button" value="v"/>	<input type="text" value="F_MWI"/>
M6	Key Event <input type="button" value="v"/>	<input type="text" value="F_CFWD"/>
M7	Key Event <input type="button" value="v"/>	<input type="text" value="F_CALLERS"/>
M8	Key Event <input type="button" value="v"/>	<input type="text" value="F_MEMO"/>
M9	Dtmf <input type="button" value="v"/>	<input type="text" value="6010"/>
M10	Memory Key <input type="button" value="v"/>	<input type="text"/>
M11	Memory Key <input type="button" value="v"/>	<input type="text"/>
M12	Memory Key <input type="button" value="v"/>	<input type="text"/>
M13	Memory Key <input type="button" value="v"/>	<input type="text"/>

There are 9 function key on the phone, and be expanded to 29 with expander board. There are 5 types of the key:

- 1.NONE: do not use this key

2.Memory Key: set Number@Line/Subtype for the key,the number will be send out if you press the key.

- Number@Line/b: BLF (need server support). You can see the status of the blf number you set.When the key is green,means the number is free now. When the key turns red and blink,means the number is ringing. When the key turns red for steady,means the number is in a conversation.
- Number@Line/m: MWI,like the voice mail key.The key will blink if there is a new voicemail.
- Number@Line/p: Presence(need server support).You can see the register status of the number.
- Number@Line/f: Speed Dial
- Number@Line/i: Push to Talk(need server support)

3.Line:

- SIP1: use sip1 to call
- SIP2: use sip2 to call
- SIP3: use sip3 to call
- SIP4: use sip4 to call
- IAX2: use iax2 to call

4.Key Event:

- F_PBOOK: Phone Book
- F_REDAIL: Redial
- F_B_TRANSFER: Blind Transfer
- F_PICKUP: Pickup(need server support)
- F_JOIN: Joincall(need server support)
- F_AUTOREDIAL: Auto redial(need server support)
- F_UNAUTOREDIAL: Cancele Auto redial(need server support)
- F_DND: Do not Disturb
- F_MWI: MWI(Message Waiting Indication) only for Sip1
- F_CFWD: Call forward(always), press down key to switch between sip1, sip2, sip3 and sip4
- F_CALLERS: Call history including Missed Call, Incoming Call.
- F_MEMO: Memorandum

5.DTMF: After set a number, if you press the key, the number will be send out.

8.5. Syslog Config



Syslog Set	
Server IP	0.0.0.0
Server Port	514
MGR Log Level	None
SIP Log Level	None
IAX2 Log Level	None
Enable Syslog	<input type="checkbox"/>

Syslog is a protocol which is used to record the log messages with client/server mechanism.

Syslog server receives the messages from clients, and classifies them based on priority and type. Then these messages will be written into log by some rules which administrator can configure. This is a better way for log management. 8 levels in debug information: Level 0---emergency: This is highest default debug info level. You system can not work.

Level 1---alert: Your system has deadly problem.

Level 2---critical: Your system has serious problem.

Level 3---error: The error will affect your system working.

Level 4---warning: There are some potential dangers. But your system can work.

Level 5---notice: Your system works well in special condition, but you need to check its working environment and parameter.

Level 6---info: the daily debugging info.

Level 7---debug: the lowest debug info. Professional debugging info from R&D person.

At present, the lowest level of debug information send to Syslog is info, debug level only can be displayed on telnet.

The items describe:

- ✓ Server IP: Syslog server IP address
- ✓ Server Port: Syslog server port
- ✓ MGR Log Level: config MGR log level
- ✓ SIP Log Level: config SIPIlog level
- ✓ IAX2 Log Level: config IAX2log level
- ✓ Enable Syslog: Enable/Disable Syslog

8.6. Time Set

IP Phone

ATCOM

[Current Status](#)
[Network](#)
[VOIP](#)
[Advanced](#)
[Dial-peer](#)
[Config Manage](#)
[Update](#)
[System Manage](#)

- [Account Manage](#)
- [Phone Book](#)
- [Multi Line Set](#)
- [Function Key Set](#)
- [Syslog Config](#)
- [Time Set](#)
- [Call Log](#)
- [Language Set](#)
- [Logout](#)
- [Reboot](#)

SNTP Time Set	
Server	<input type="text" value="209.81.9.7"/>
Timezone	(GMT+08:00)Beijing,Chongqing,Hong Kong,Urumqi ▼
Timeout	<input type="text" value="60"/> (seconds)
12 Hours Systems	<input type="checkbox"/>
Sntp	<input checked="" type="checkbox"/>

Daylight Timeset		
Enable daylight	<input type="checkbox"/>	
	Start Date	End Date
Months	March ▼	October ▼
week	5 ▼	5 ▼
Day	Sunday ▼	Sunday ▼
Hour	<input type="text" value="2"/>	<input type="text" value="2"/>
Minute	<input type="text" value="0"/>	<input type="text" value="0"/>

- ✓ Server: type the IP address of time server
- ✓ Timezone: select correct time zone in list box
- ✓ Timeout: longest response time for SNTP
- ✓ Daylight Timeset: daylight setting through manual
- ✓ Manual Timeset: Time setting through manual
- ✓ Enable Daylight: Daylight saving time

You can also set the time manually.

Manual Timeset	
Year	<input type="text"/>
Months	<input type="text"/>
Day	<input type="text"/>
Hour	<input type="text"/>
Minute	<input type="text"/>

ATCOM TECHNOLOGY CO., LIMITED

8.7. Call Log

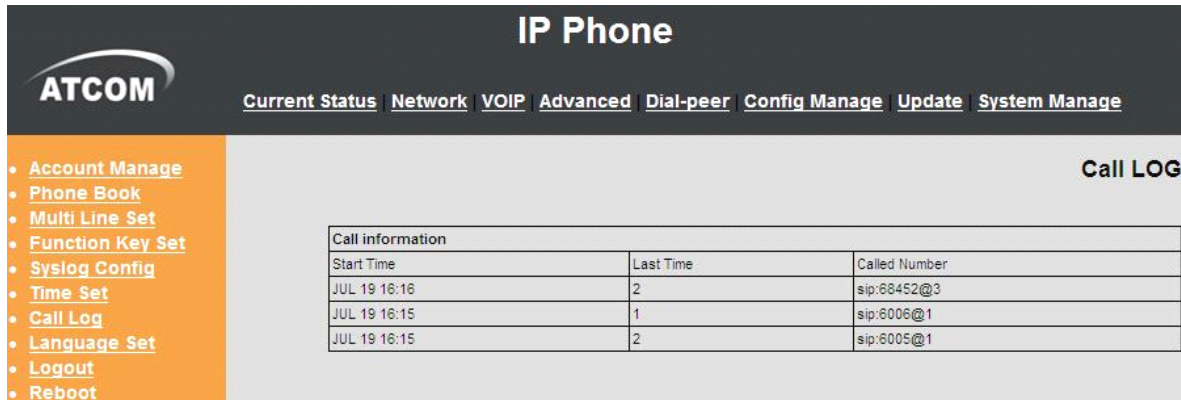

Call information		
Start Time	Last Time	Called Number
JUL 19 16:16	2	sip:68452@3
JUL 19 16:15	1	sip:6006@1
JUL 19 16:15	2	sip:6005@1

- ✓ Start Time: Display starts time of the outgoing record.
- ✓ Last Time: Display conversation time of the outgoing record.
- ✓ Called Number: Display the account/protocol/line of the outgoing record.

Notice:

It will cover existing automatically if the call log table has the new record. Call log will be cleared after phone reboot.

8.8. Language Set



LANGUAGE SELECTION	
Language Set:	English ▼
<input type="button" value="APPLY"/>	

Language Set: Set the language of phone, English is default. Because we use 14px font on LCD so the Chinese and Korean language are not supported but only can be supported on web. The default language is English, if you need other language support; please feel free to contact our sales.

8.9. Logout



Log out the configuration mode. If you want to re-configuration the phone, need to input the user and password to login again.

8.10.Reboot



Reboot IP phone, some settings need reboot to make it works. Please always save config before reboot, otherwise the settings will return to previous settings.