



A68(W) IP Phone User Manual

Version: 1.0

2016-03-24

Content

Contact ATCOM	5
1、 Overview of A68(W).....	6
1.1、 Interface.....	7
1.2、 Hardware.....	7
1.3、 Software.....	7
1.4、 Network.....	8
1.5、 Management and Maintenance	8
1.6、 Protocol	8
1.7、 Compliant and Certified Standard	9
1.8、 Packing list.....	9
1.9、 Installation.....	10
2、 Call Function	13
2.1、 Answer the calls.....	13
2.2、 Make Calls.....	14
2.3、 Pre-dial.....	15
2.4、 Multiple line dial-up	15
2.5、 Call Hold	16
2.6、 Call Transfer.....	16
2.7、 Mute calls	17
2.8、 3-Way Conference.....	18
2.9、 Hang up the phone.....	18
2.10、 Voicemail	19
3、 Keypad and GUI	19

3.1、Keypad	19
3.2、Starting	21
3.3、Standby	22
3.4、Configuration.....	24
3.4.1、Status info	25
3.4.2、Call Features	27
3.4.3、Directory	43
3.4.4、History	51
3.4.5、Message	54
3.4.6、Settings.....	56
3.4.7、Display	75
4、Advanced Feature.....	79
4.1、Codecs	79
4.2、Capture and Upgrading	80
4.3、Auto Provision	81
4.4、Export & Import configuration file.....	83
4.4.1、Export configuration file	83
4.4.2、Import configuration file.....	84
4.5、Export System log.....	84
4.6、Dial plan	85
4.6.1、Replace Rule	86
4.6.2、Dial-now.....	87
4.6.3、Area Code.....	88
4.6.4、Block Out.....	89

5、WI-FI(only for A68W)	91
5.1、Configure the wifi on the phone.....	91
5.2、Configure the wifi on the WEB.....	91
6、FAQ	92
6.1、How to reset to factory	92
6.2、Upgrade the firmware on safe mode	93
6.3、How to make IP Peer to Peer call.....	94
7、Troubleshooting	94
7.1、Thephone is failed to register to SIP server	94
7.2、Thephone is failed to gain IP address	94
7.3、Only one party can hear from another on calling	95
8、Abbreviation	95

Contact ATCOM

Overview of ATCOM

ATCOM is the leading VoIP hardware manufacturer in global market. We have been keeping innovating with customer's needs oriented , working with partners to establish a total solution for SMB VoIP with IP phone , IP PBX and Asterisk cards.

With over 10 years' experience of R&D , manufacturing and service in network and VoIP filed;mission of creating the biggest value for IP terminals , we commit ourselves in supplying the competitive IP phone and other terminals for IP PBX , softswitch , IMS , NGN providers and carriers; supplying the competitive total VoIP solution for SMB market. We keep improving the customer's experience and creating the bigger value with our reliable products. Until now, our VoIP products have been available in 100+ countries and used by millions of end users.

Contact Sales

Address	Area C, A2F , Block 3 ,Huangguan Technology Park , #21 Tairan 9th Rd, Chegongmiao , Futian District , Shenzhen China
Tel	+ (86) 755-83018618-8806
Fax	+ (86) 755-83018319
E-mail	sales@atcomemail.com

Contact Technical Support

Tel	+ (86) 755-83018618-8008
E-mail	Support@atcomemail.com

Website Address: <http://www.atcom.cn/>

Download Center: <http://www.atcom.cn/download.html>

1、 Overview of A68(W)



A68(W)



A68(W)with Rainbow ET

1.1、Interface

Power Input	DC 5V-2000mA or PoE
LANPort	RJ45
PC Port	RJ45
EXPAN Port	RJ45
Headset Jack	RJ9
Handset Jack	RJ9

1.2、Hardware

LCD	480x272 4.3" TFT
FLASH	1Gbit
RAM	1Gbit
CPU	500MHz Dual-Core
LED Indicator	1 Status Light , 6 line indicators, 8 BLF indicators, 1 voicemail indicator, 1 headset indicator, 1 mute indicator
Rainbow ET Expansion Module	44 programmable keys on each Rainbow ET.

1.3、Software

- Sip 2.0 (RFC3261) and other related SIP RFCs
- 6 SIP lines registration
- STUN
- Jitter Buffer, VAD,CNG
- G711A/u, G722, G726-16, G726-24, G726-32, G726-40, G729, Lin16-16, iLBC
- Echo Cancellation
- SIP Domain name, Authentication and Backup SIP Server
- DTMF (Inband, RFC2833, SIP INFO)
- Call transfer, Call forward, 3-way conference, Call hold, Call back
- DND(Do Not Disturb), Auto answer, Blacklists, Block Call-ID, Block Anonymous call, Dial plan, IP call

- Phone book with 200 records, 200 answered calls, 200 missed calls, 200 dialed calls
- Auto update via HTTP, HTTPS,FTP, TFTP, PNP
- Syslog
- SNTP,NTP
- Customized Ringtone
- Daylight Saving time
- VLAN, VPN
- WEB access with different login level
- Multi-language:English, Chinese, Farsi, French, German, Hebrew, Italian, Portuguese, Russian, Spanish, Turkish

1.4、 Network

- LAN/PC: Support Bridge mode
- Support VLAN
- Support L2TP VPN
- Support DHCP、 STATIC、 PPPoE
- Primary/SecondaryDNS Server
- Support QoS
- Web access via HTTP&HTTPS

1.5、 Management and Maintenance

- Support safe mode and firmware updating under safe mode
- Support different level user management
- Configuration via web , keyboard
- Support multi-language
- Firmware and configuration file auto provision
- Support system log

1.6、 Protocol

- IEEE 802.3 /802.3 u 10 Base T / 100Base TX
- PPPoE: PPP over Ethernet
- DHCP: Dynamic Host Configuration Protocol
- SIP RFC3261, RFC3262, RFC3263, RFC3264, RFC3265, RFC2543, RFC3489, RFC3842, RFC3515, RFC2976, RFC3428, RFC2327, RFC2782, RFC1889

- TCP/IP: Transfer Control Protocol/Internet Protocol
- RTP: Real-time Transport Protocol
- RTCP:RTP Control Protocol
- DNS: Domain Name Server
- TFTP: Trivial File Transfer Protocol
- HTTP:Hypertext Transfer Protocol
- FTP:File Transfer Protocol

1.7、 Compliant and Certified Standard

- CE: AGC01180140201E2, AGC01180140202E2
- Comply with ROHS in EU
- Comply with ROHS in China



-
- Operation temperature: lower than 60° C
- Storage temperature: lower than 60° C
- Humidity: 10 to 90% no dew

1.8、 Packing list

Model	A68(W)
Telephone	1Unit
Handset	1 Unit
Handset cable	1 Unit
Stand bracket	1Unit
Power adapter	Optional
Network Cable	1 unit, 1.5 meters
CD (User mnuaal)	1 Unit
Rainbow ET	Optional
Headset	Optional

1.9、 Installation

A68(W) is able to be connected with network via LAN port. Under the Bridge mode, other devices (Laptop, IP phone) is able to access network via the PC port of Rainbow 4(S).

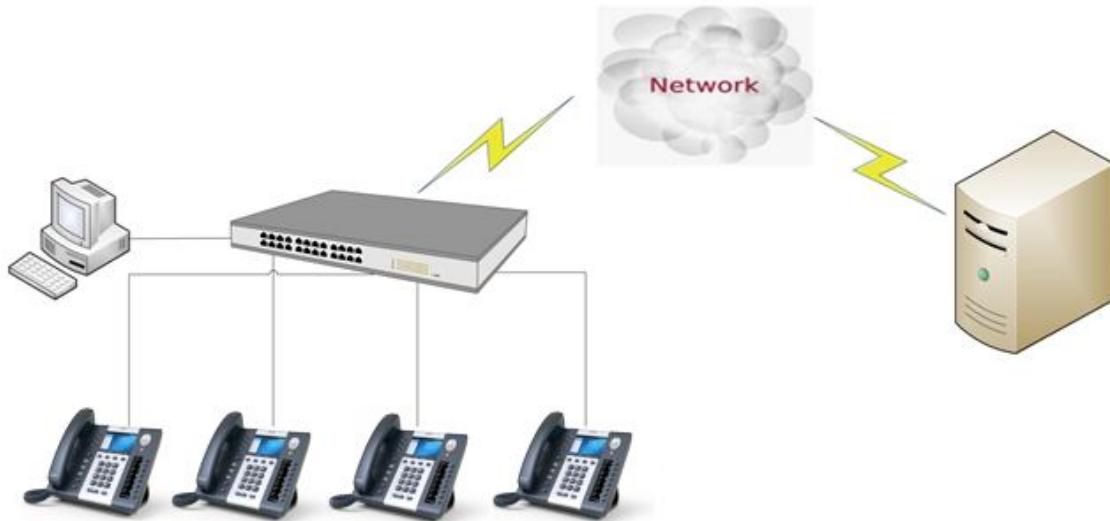

1、 Stand bracket installation instruction

A. Put the bottom side of the IP phone upside and press one-side joints of stand bracket into the slot, please refer the picture as below:

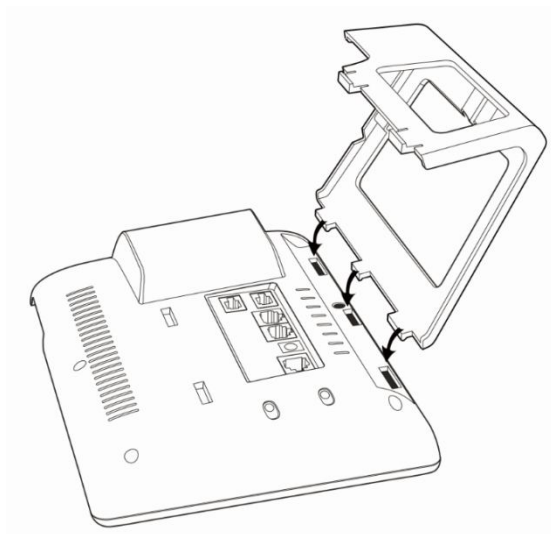

B. Press the other side joints into the slot according to the direction of the arrow:

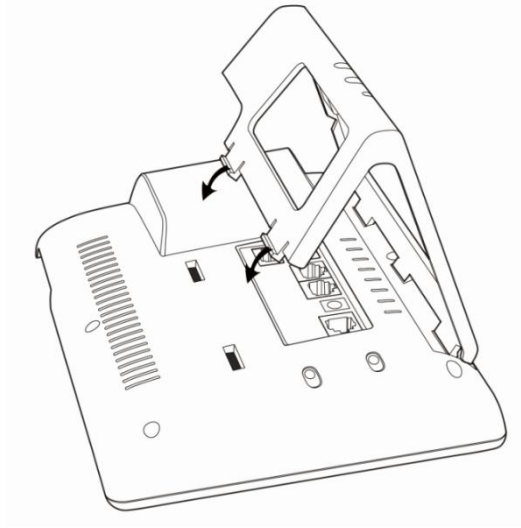

C. It is the right picture after fixing the stand bracket below:

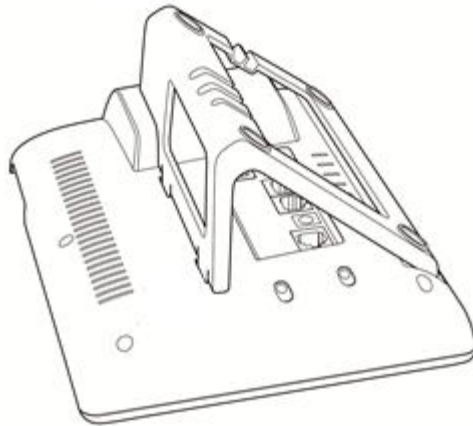

D. Disassemble the stand bracket:

Push the spring joint of stand and pull the stand according to the direction of the arrow. When the joints are pulled out of the slot, you can take off the stand bracket

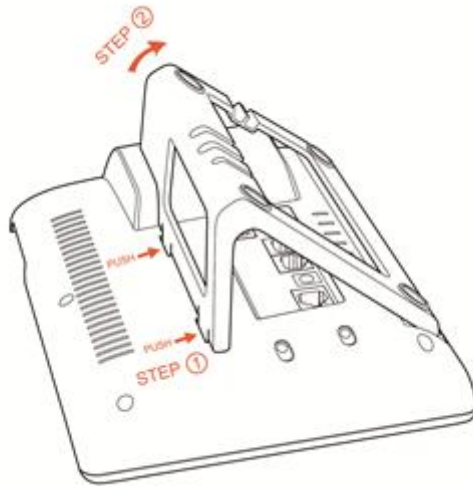

2. Wiring instruction

Plug in the power adapter, cable and handset or headset to the corresponding ports as below picture and press them to the slots on the stand bracket.

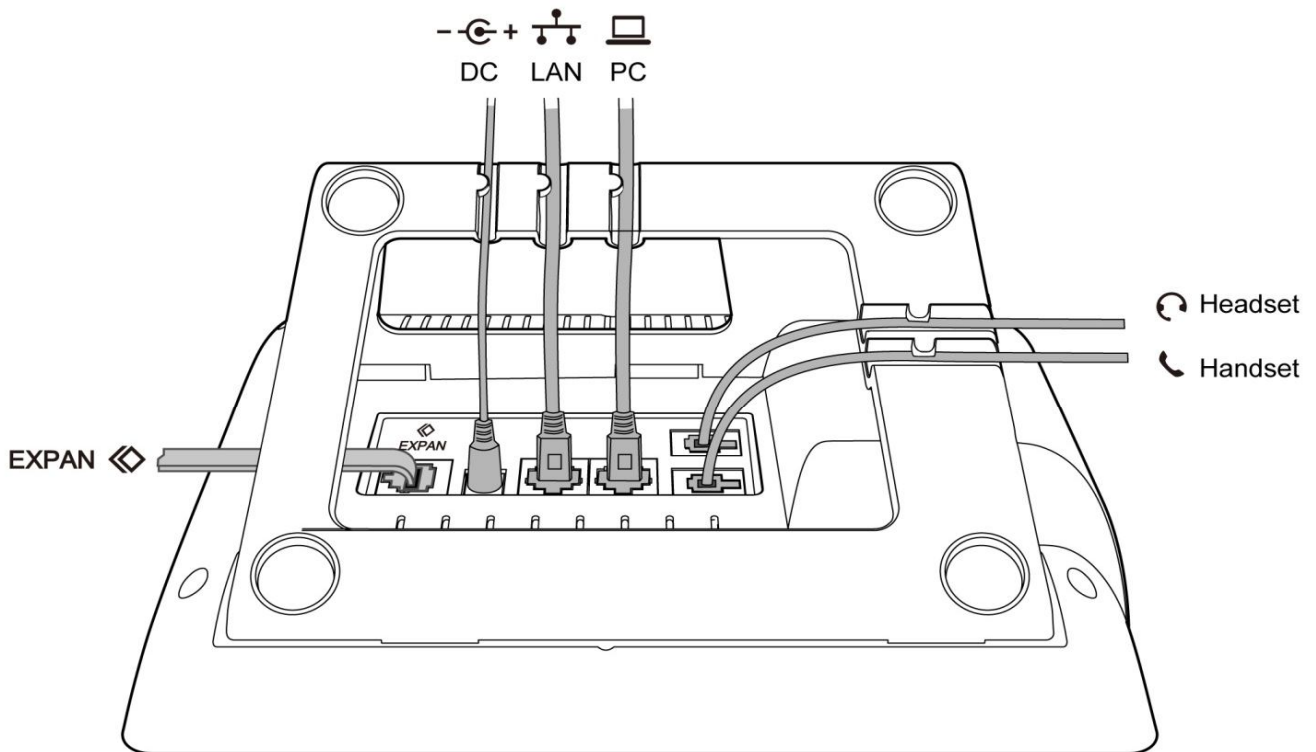



2、 Call Function



2.1、 Answer the calls

When there is an incoming call, phone will remind user with ringing. There are 3 ways to answer the call:



A. Answer by handset

Pick up the handset and talk with the caller. If you want to hang up, just put back the handset. When you are talking with the handset and want to switch to speaker or headset mode, please press  key or  key, and then put down the handset.

B. Answer by speaker

Press  key and talk with callers by built-in Micro-phone and Speaker. If you want to hang up, please press  key again. Switch calling or talking into handset mode by lifting the handset under speaker mode. Press  key will switch calling or talking into headset mode.

C. Answer by headset

Keep your microphone connected with the RJ9 headset jack, when there is an incoming call, press  and talk with the caller. If you want to hang up, please press  again. Pressing  can change calling or talking into speaker mode, and lifting the handset switches to handset mode.

2.2、 Make Calls

A. Use the handset

Pickup the handset, the LCD will show the current lines (user is able to switch from line1 to line6 by pressing the line key beside the LCD). Press soft key "**Send**" to dial the number. When you hear the tones of "du~~du~~" and the phone number your dialed is being displayed on the LCD, the phone at the side of being called should be ringing. If the called party answers this calling, the call is established and the calling timer is started immediately.

B. Use the speaker

Press  key, the LCD will show the current lines (user is able to switch from line1 to line6 by pressing the line key beside the LCD). Input the phone number and press soft key "**Send**" to dial the number. When caller hear the tones of "du~~du~~" and the phone number your dialed is being displayed on the LCD, the phone at the side of being called should be ringing. If the called party answers this calling, the call is established and the calling timer is started immediately.

C. Use the headset

Press  Key, the LCD will show the current lines (user is able to switch from line1 to line6 by pressing the line key beside the LCD). Input the phone number and press soft key "**Send**" to dial the number. When caller hear the tones of "du~~du~~" and the phone number your dialed is being displayed on the LCD, the phone at the side of being called should be ringing. If the called party answers this calling, the call is established and the calling timer is started immediately.

D. Dial from phone book

1. Press  key to enter the menu and choose "**Directory**" option. Press "**Enter**" soft key and then find the contact person by navigation keys. When the certain contact person is highlighted, press "**Dial**" or just pick up the handset to call this number.
2. Pick up the handset, press "**Directory**" soft key, then find the contact person and press "**Dial**" soft key.

3. Pick up the handset, press  and enter "**Directory**", then find the contact person and press "**Dial**" soft key.

E. Dial from call history

1. Press  key to enter the menu and choose "**History**" option, then select one of call history entry, and press "**Dial**" soft key or pickup the handset to call this number.

2. Pickup the handset, press "**History**" soft key, then select one of call history entry, and press "**Dial**" soft key to call this number.



3. Pickup the handset, press  and enter "**Call History**", then select one of call history entry, and press "**Dial**" soft key to call this number.

2.3、 Pre-dial

It's a method to dial a phone number immediacy at standby mode.

The method is as below:

A. Dial-up the phone number at standby mode

B. Press soft key "**Dial**" or Pick up the handset or Press  or  to send out the number.



2.4、 Multiple line dial-up

A68(W) supports 6 SIP lines. That means user can register 6 different sip accounts simultaneity. User is able to choose line1, line2, line 3 , line 4, line 5 or line 6 by pressing corresponding line key. Line1 or the 1st Line registered successfully under idle is the priority to pick up the calls.

A68(W) maximum supports 24 concurrent calls, that means 24 calls can be setup on each of single line, but the total number of concurrent calls on all lines can not more than 24. When there is an incoming call to another line, LCD will show the incoming phone number and line



LED will be blinking in green. User is able to press the corresponding line key or press soft key **"Hold"** the current line on which you're talking then press **"Answer"** to receive the incoming call from another line.

Pick up a new incoming call while on calling: When a new incoming call happened on the being

occupied line, press the key  or  to check details of the new incoming call, and press the soft key **"Answer"** on GUI to pick up the new call. The current calling will be hold after the new call picked up. When a new incoming call happened on another idle line, the source phone number of new incoming call will be displayed on the Screen and the LED of corresponding line key will be fast blinking (Green), Press the corresponding line key to pick up the new call, Or Press the soft key **"Hold"** to hold the current call and then press **"Answer"** key to pick up the new call.

Make a new call while on calling: To make a new call on a being occupied line, Press the key **"Hold"**, then input the destination phone number and press the key **"Dial"**, or Press the soft key "New", then input the destination phone number and press the key **"Dial"**. To make a new call on an idle line, press the corresponding line key, input the destination phone number and press the key **"Dial"**.

2.5、 Call Hold

The current calling will be hold by pressing soft key **"Hold"** or , and the held call will be resumed after pressing soft key **"Resume"** or  or the corresponding line key. Even on 3-way conference calling, the conference will be held after pressing **"Hold"** key, and be resumed to 3-way conference after pressing **"Hold"** Key again. Remember the conversation is still on hold without being ended even if hung up under the status of hold.

2.6、 Call Transfer

1. Attended call transfer

The attended transfer allows user to call a third-party before transferring the calling.

While calling, press the "**Transfer**" soft key to hold the current call and dial the target number you want to transfer to on the activated line and press "**Send**" soft key to call that number. After the target party answers the call, press "**Transfer**" soft key again to complete the transfer.

If the target number has been setup in the current BLF list, and you have already finished the necessary setup on Webpage of A68(W), there is an easier way to complete the attend transfer. While calling, press the corresponding BLF key of the target number and then press the "**Transfer**" soft key, the attend transfer will be achieved.

Setup BLF list with attend transfer functions on Webpage:

"Phone"→"Features"→"Transfer Settings"→"Transfer Mode via DSS Key (Attend Transfer)"

2. Blind call transfer

The blind transfer allows user to transfer a call without speaking to the third party. On the user side, the call will be ended as soon as the target phone number is dialed.

Operating steps: Press "More" soft key to get more option, then press "Bxfer" soft key, input the transfer target number and press "Send" soft key.

If the target number has been setup in the current BLF list, and you have already finished the necessary setup on Webpage of A68(W), there is an easier way to complete the Blind transfer. While calling, press the corresponding BLF key of the target number, the blind transfer will be achieved.

Setup BLF list with blind transfer functions on Webpage:

"Phone"→"Features"→"Transfer Settings"→"Transfer Mode via DSS Key (Blind Transfer)"

2.7、Mute calls

The input audio will be not transmitted to peer phone after pressing  key, and the phone will be muted even switched among different modes of speaker, handset and headset.

To un-mute, just press  key again.

2.8、3-Way Conference

1. While on calling, press the soft key "**Conf**", input the 3rd party's phone number and then press the softkey "**Dial**" or press the soft key "**Conf**" and press the corresponding BLF key to invite the 3rd party to join a conference call.
2. After the third party answers the call, pressing "**Conf**" key again to establish the 3-way conference
3. The initiator of 3-way conference can press the soft key "**Hold**" to hold the conversation with other two parties, and press "**Resume**" to back to 3-way conference.
4. If the initiator hangs up the call or press the soft key "**End Conf**", the conference will be ended and the calling between the other two parties will be hung up as well.
5. The initiator of 3-way conference can press the soft key "**Split**" to separate the conference call, and the calling between initiator and the other two parties are still active but under the status of Call hold.
6. After split the 3-way conference, press the soft key "**More**" and then press the softkey "**Join**" to resume the 3-way conference or press the softkey "**Conf**" to setup a new 3-way conference call.

2.9、Hang up the phone

1. Softkey hang up

While on calling, press the softkey "**End Call**" to hang up.

2. Handset hang up

Put back the handset at handset mode, the current calling will be hung up.

3. Speaker hang up

Press  key at speaker model, the current calling will be hung up.

4. Headset Hang up

Press  key at headset model, the current calling will be hung up.

5. Hang up one line call

Press the hook to hang up the current calling when 2 calls happened simultaneously.

2.10、Voicemail

A68(W) has a  key for entering voicemail box and indicating new voicemail. Press

 key to enter the menu to configure voicemail number if you have never configured it previously. Otherwise, the voicemail number will be called after pressing it.







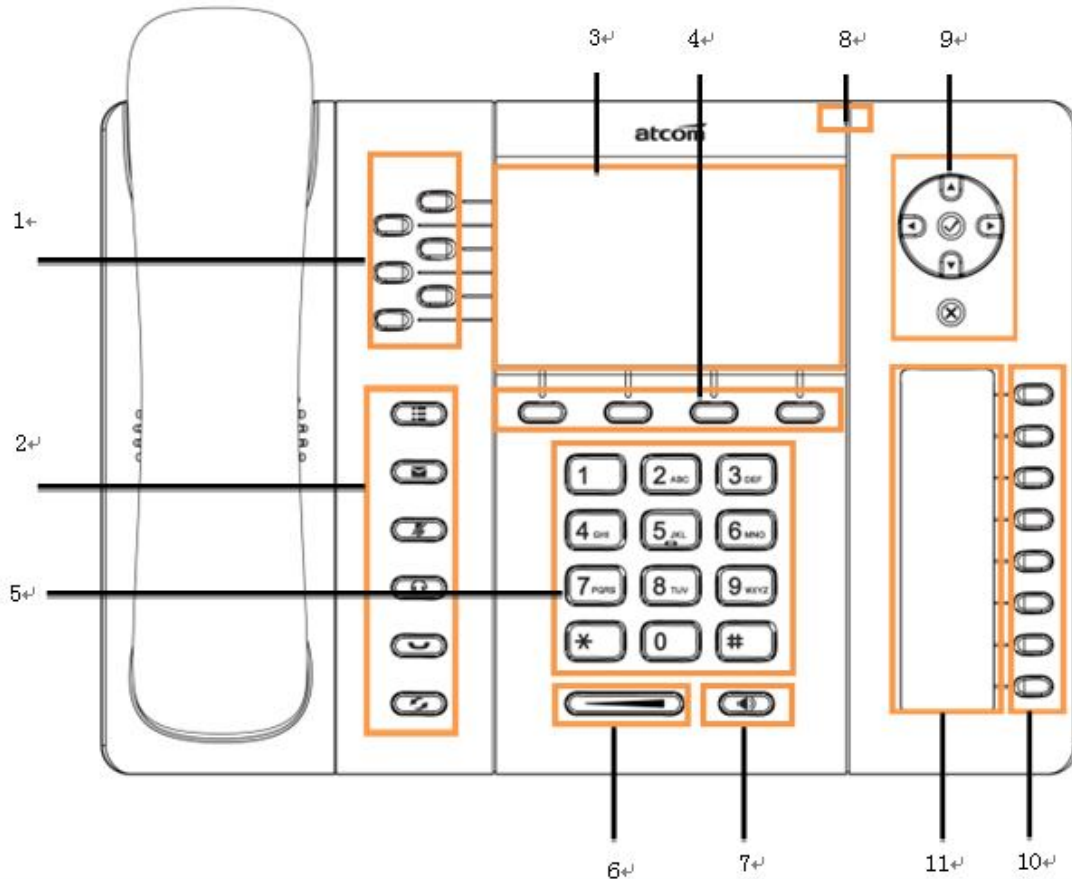

3、Keypad and GUI

3.1、Keypad

Description of the keys and Screen

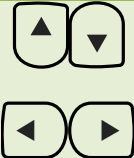

Item	Name or Icon	Description
1	Line Key and Status Indicator	<p>Programmable keys with built-in Red/Green dual-color LED lights to indicate different status of each line,</p> <ul style="list-style-type: none"> ● Green on always—the current line is being occupied ● Green fast blinking—A new incoming call on the current line ● Red on always—The remote end of SLA is busy ● Green slow blinking—Calling on the current line has been hold by the remote end ● Red slow blinking — Calling on the current line has been hold by local end.
2		Enter/Quit Menu
		Access & Manage the Voicemail
		Mute
		Make a call or answer a call on headset

		Hold/Resume a call
		Re-dial the latest dialed phone number
3	Main LCD Display	Display Calling details, Message, Softkey, Time, Date and other info.
4	Softkey	Press to select a function which displayed at the softkey zone of screen. Display all optional functions at the last line of LCD screen.
5	Dial pad	Entering numbers or characters.
6		Adjust the volume (speaker/handset/headset/ring). Volume level will be displayed on LCD when pressing volume key.
7		Pick up and hung up under the speaker mode.
8	Status Indicator	The Status Indicator (LED) will be Red slow blinking when new incoming call or Voicemail.
9		Allow users to navigate (left, right, up, down). Press  can enter "Directory". Press  can enter "History".
		Confirm users' operation and show status when Rainbow2 is idle.
		Cancel users' operation.
10	Memory Key and Status Indicator	Aside the BLF LCD display, Programmable keys with built-in Red/Green dual-color LED lights to indicate different status: <ul style="list-style-type: none"> ● Off—The account is unregistered ● Green on always—The account is idle. ● Red on always —The account is being occupied. ● Red fast blinking—The account is ringing.
11	BLF LCD Display	Display the content of each programmable key.

3.2、Starting

All lights will be on (Red) at the moment when the phone powered on, and then light off in the following One second. And then the phone turns to standby status in about 50 seconds.













3.3、Standby



Area Item	Description
1	Status: to indicate the call status
2	Time
3	Background
4	Softkey: “ History ”, “ Directory ”, “ Forward ”, “ DND ”
5	Indication info: DND (on)、Missed calls, Call Forward (on) and Network Status (unavailable).
6	Time, Date
7	Programmable keys (Line Keys in default)

Icon on Standby UI

Icon	Description
	The account is registered successfully, and displayed in the Area 7.
	The account is not registered successfully, and displayed in the Area 7.
	The line is being occupied for dialing, and displayed in the Area 7.
	The line is on calling, and displayed in the Area 7.
	New incoming call, and displayed in the Area 7.
	Call hold, and displayed in the Area 7.
	3-way conference calling, and displayed in the calling UI.
	Call being hold, and displayed in the calling UI.
	Unavailable Network, and displayed in the Area 5.
	Calling via handset, and displayed in the Area 1.
	Calling via Speaker, and displayed in the Area 1.

	Calling via headset, and displayed in the Area 1.
	WiFi Signal indicator, and displayed in the Area 1.
	Call Forward is activated, and displayed in the Area 1.
	New Voicemail, and displayed in the Area 1.
	Volume turn to be "0", and displayed in the Area 1.
	Auto-Answer is activated, and displayed in the Area 1.
	DND is activated, and displayed in the Area 1.

3.4、 Configuration

Press the key  to enter the Main Menu:



Move the cursor via navigation key and press the softkey **“Enter”** or input the corresponding Number key Select the item of Main Menu:

Number Key “1”	Enter “Status”
Number Key “1”	Enter “Feature”
Number Key “3”	Enter “Directory”
Number Key “4”	Enter “History”
Number Key “5”	Enter “Message”
Number Key “6”	Enter “Settings”
Number Key “7”	Enter “Display”

3.4.1、Status info



It's able to check the status info via LCD Display or Web.

And the basic status and details status will be optional displayed on LCD display

1. Basic Status——IP address、MAC address、Firmware version。
2. Details Status——Network info、Production info and Account info in details.

Basic Status

You're able to check the basic status in both ways as below:

1. **Press the key**  **on standby.**
2. **Press the key**  **and select the “Status” of Main Menu.**



Details Status

Select "**More**" and then press the softkey "**Enter**" to check details info.



Press the softkey "**Enter**" to check status info, and "**Back**" to return the Basis Status page.

Check the Status info via Web

1. Check the IP address of IP phone;
2. Type the IP address on a web browser;

3. Input the username and password, the default user and password for Administrator is (admin, admin), for general user is (user, user), and then press "**Enter**".
4. By default, the Status info will be displayed.

3.4.2、 Call Features

In this part, we will introduce the following content:

- [Call Forward](#)
- [Call Waiting](#)
- [Auto Answer](#)
- [DSS keys](#)
- [Key as send](#)
- [Hotline](#)
- [Anonymous Calls](#)

1. Call Forward

"Call Forward" includes "Always Forward", "Busy Forward", "No Answer Forward".



"Always Forward" has the highest priority, and "Busy Forward" has the same priority as "No Answer Forward", that means once the function of "Always Forward" is activated, other call forward features will be unavailable.

Any type of Call forward feature is activated, the Icon  will be indicated on the LCD Display, and the soft key "Forward" (at the bottom line of LCD display) will turn to be "-Forward".

Always Forward

All incoming calls will be forwarded to target phone number once the “**AlwaysForward**” activated, setup this feature as follow:





Item	Operation	Description
Always	Press the key  ,  or the soft key “ Switch ” to setup	Switch on or Switch off the feature. “ Enable ” mean this feature is enabled, “ Disable ” mean this feature is disabled.
Forward to	The Number key, “*”key, and “#”are permitted to be input.	Setup the target phone number which all incoming calls transferred to
On Code	The Number key, “*” key, and “#”are permitted to be input.	The feature code to enable all incoming calls forward, the phone will send the feature code directly to open all incoming calls forward
Off Code	The Number key, “*” key, and “#”are permitted to be input.	The feature code to disable all incoming calls forward, the phone will send the feature code directly to close all incoming calls forward

Busy Forward

It means the phone is busy once the phone is not at standby mode. Setup this feature as below:





Busy Forward	
1. Busy Forward	Enable
2. Call(s) forward to	6039
3. On Code	#37
4. Off Code	#377
Save	Switch
	Back

Item	Operation	Description
Busy	Press the key  or  or softkey " Switch " to setup	Switch on or Switch off the feature. " Enable " mean this feature is enabled, " Disable " mean this feature is disabled.
Forward to	The Number key, "*" key, and "#" are permitted to be input.	Setup the target phone number which all incoming calls transferred to
On Code	The Number key, "*" key, and "#" are permitted to be input.	The feature code to enable busy calls forward, the phone will send the feature code directly to open busy call forward
Off Code	The Number key, "*" key, and "#" are permitted to be input.	The feature code to disable busy calls forward, the phone will send the feature code directly to close busy call forward

No Answer Forward

All incoming calls will be forwarded after time out, once the feature of "NoAnswer Forward" is activated. Setup this feature as below,

No Answer Forward	
1. No Answer	Enable
2. Call(s) forward to	6038
3. After Ring Time	12s
4. On Code	#38
5. Off Code	#388
Save	Switch
	Back

Item	Operation	Description
No Answer	Press the key   or softkey " Switch " to setup	Switch on or Switch off the feature. "On" mean this feature is activated, "Off" mean this feature is unactivated .
Forward to	The Number key, "*" key, and "#" are permitted to be input.	Setup the target phone number which all incoming calls transferred to
After Ring Time	Press the key   or softkey " Switch " to setup	Setup timer for no answer status. All incoming calls will be forwarded after time out once Call forward when no answer activated.
On Code	The Number key, "*" key, and "#" are permitted to be input.	The feature code to enable no answer call forward, the phone will send the feature code directly to open all incoming calls forward
Off Code	The Number key, "*" key, and "#" are permitted to be input.	The feature code to disable all incoming calls forward, the phone will send the feature code directly to close all incoming calls forward

Setup Call Forward Via Web

Set Call Forward via web: **Phone**→**Features**→**Forward**.

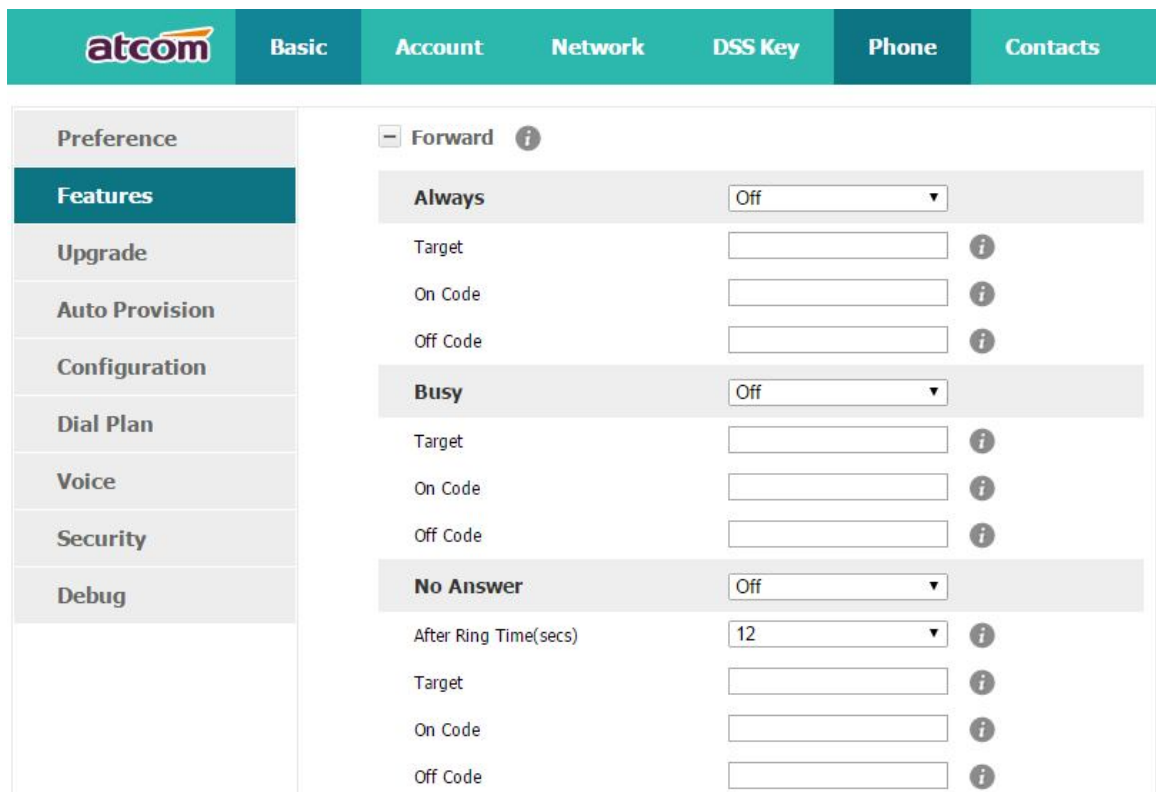

Preference	Basic	Account	Network	DSS Key	Phone	Contacts
Preference						
Features						
Upgrade						
Auto Provision						
Configuration						
Dial Plan						
Voice						
Security						
Debug						





Forward	
Always	Off
Target	<input type="text"/>
On Code	<input type="text"/>
Off Code	<input type="text"/>
Busy	Off
Target	<input type="text"/>
On Code	<input type="text"/>
Off Code	<input type="text"/>
No Answer	Off
After Ring Time(secs)	12
Target	<input type="text"/>
On Code	<input type="text"/>
Off Code	<input type="text"/>

2. Call Waiting

The feature of "Call Waiting" is available by default. If switch off this feature, whatever multiple SIP accounts had been registered successfully, only one single active calling is permitted (for example Dialing, Ringing, Calling, Holding).



Call Waiting	
1. Call Waiting	Enable
2. Call Waiting Tone	Enable
Save	Switch
	Back

Item	Operation	Description
Call Waiting	Press the key  、  or softkey "Switch" to setup	Switch on or Switch off the feature. "Enable" mean this feature is enabled, "Disable" mean this feature is disabled.
Call Waiting Tone	Press the key  、  or softkey "Switch" to setup	Switch on or Switch off the prompt playing. "Enable" mean this feature is enabled, "Disable" mean this feature is disabled .

Setup call waiting via web: **"Phone"**→ **"Feature"**→ **"General information"**→ **"Call Waiting"**.

Setup call waiting Tone via web: **"Phone"**→ **"Feature"**→ **"Audio Settings"**→ **"Call Waiting Tone"**.

3. Auto Answer

The feature of "Auto Answer" is switched off by default. All incoming calls will be answered automatically when the phone is standby once "Auto Answer" is activated. "Auto Answer" when the phone is under "on Calling" status.

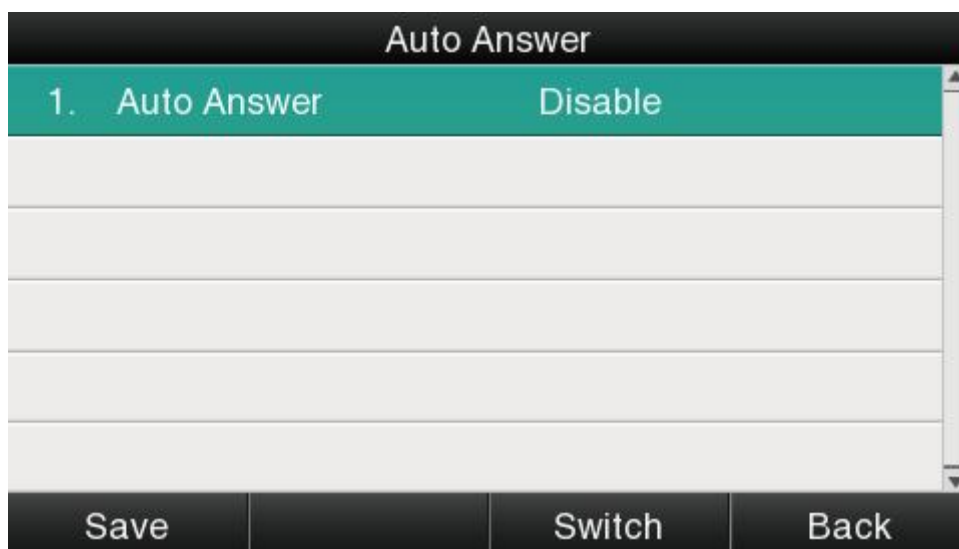

The Icon  will be indicated once "Auto Answer" is available.

Setup "Auto Answer" via Web: "**Phone**" → "**Feature**" → "**General information**" → "**Auto Answer**"

4. DSS Keys

The programmable keys include Line keys, Memory keys (aside the BLF LCD Display). Programmable feature keys and Soft key on Standby UI.

Press the programmable key for 2 seconds, you're able to modify the feature of each programmable key.

All programmable keys has been classified as "N/A", "Line Key", "BLF", "Key event", "Speed dial", "Intercom"

And the "Key Event" has been classified as "Conference", "Hold" "DND", "Redial", " Call return", "Pickup", "Call Park", "DTMF", "Directory".

Comments:



N/A

N/A means this key is not permitted to be set as a programmable key.

Line key

Display the account information, press it for making a call, answering incoming calls, call hold and resume.



Line Key1	
1. Type	Line Key
2. Account ID	Account 1
3. Account name	
4. SIP Server	
Save	Switch
	Back

Item	Description
Account ID	To display the account ID, press the soft key " Switch " or  、  to modify, the optional value is Account 1 to 6.
Account name	Display the account name of each account ID, non-modifiable.
SIP Server	The SIP server of each Account ID, non-modifiable. If not set any value for some account ID, the account name will be null.

BLF

Indicate the status of monitored account. Once set the BLF key with Pickup feature, user is able to answer the incoming call to the monitored account by pressing the corresponding BLF key. If the monitored account is idle, press the corresponding BLF key for speed dial.

Line Key1	
1. Type	BLF
2. Account ID	Account 1
3. Label	blf
4. Value	6070
5. Extension	*8
<div style="display: flex; justify-content: space-around;"> Save Switch Back </div>	

Item	Description
Account ID	To display the account ID, press the soft key " Switch " or  、  to modify, the optional value is Account 1 to 6.
Label	To identify this key on LED, for example "blf"
Value	The phone number will be monitored by this key. For example, if user want to monitor the phone number (6070), please set "6070" here.
Extension	This code must be set for pickup, and this code provide by Server. If the code is not matched by Server, the feature of pickup will not work.

Conference

The 3-way conference will be setup by pressing the key "Conf" while on calling. For more info, please refer to [Chapter 2.8](#).

The configuration item **Label** is a name to identify the key on LED, can be set as "conference".

Hold

The same feature as the key . For more info, please refer to [Chapter 2.5](#).

The configuration item **Label** is a name to identify the key on LED, can be set as "hold".

DND

Press this key will switch on or switch off the feature of "DND".

The configuration item **Label** is a name to identify the key on LED, can be set as "DND".

Redial

The same feature as the key .

The configuration item **Label** is a name to identify the key on LED, can be set as "redial".

Call return

Automatically dial the latest phone number in history.



The configuration item **Label** is a name to identify the key on LED, can be set as "return".

Call Pickup

Press this key to pick up if new incoming call to the monitored phone number.

Line Key1	
1. Type	Key event
2. Event	Pickup
3. Account ID	Account 1
4. Label	pickup
5. Value	6001
<div style="display: flex; justify-content: space-around;"> Save Switch Back </div>	

Item	Description
------	-------------

Account ID	To display the account ID, press the soft key "Switch" or  、  to modify, the optional value is Account 1 to 6.
Label	To identify this key on LED, for example "pickup"
Value	The phone number monitored for pickup

Reminding: This code must be set for pickup, and this code can be set via Web only.

Set the Pickup code as follow:

Set the pickup code for one single Account: **Account**→**Advanced**→**Select an account to be configured**→**Directed Call Pickup Code**.



Set the pickup code for all Accounts: **Phone**→**Features**→**Call Pickup**→**Direct Call Pickup**、**Direct Call Pickup Code** (**Direct Call Pickup should be set as Enable**) .

Call Park

Press this key while on calling, the phone will dial the specified phone number, user will receive a code on the phone prompt, and then press the soft key "Transfer", the current calling will be parked successfully. At this moment, user is able to continue the parked calling with any other phones which registered on the same SIP server by dialing the code which user have received.

Line Key1	
1. Type	Key event
2. Event	Park
3. Account ID	Account 1
4. Label	park
5. Value	700
<div style="display: flex; justify-content: space-between; padding: 0 10px;"> Save Switch Back </div>	

Item	Description
------	-------------

Account ID	To specify an account to park the call, press the soft key " Switch " or  、  to modify, the optional value is Account 1 to 6.
Label	To identify this key on LED, for example as "park".
Value	The code for pickup the parked call and it is provided by SIP server.

DTMF

Press this key while on calling, the phone will send the configured "**Value**" automatically.

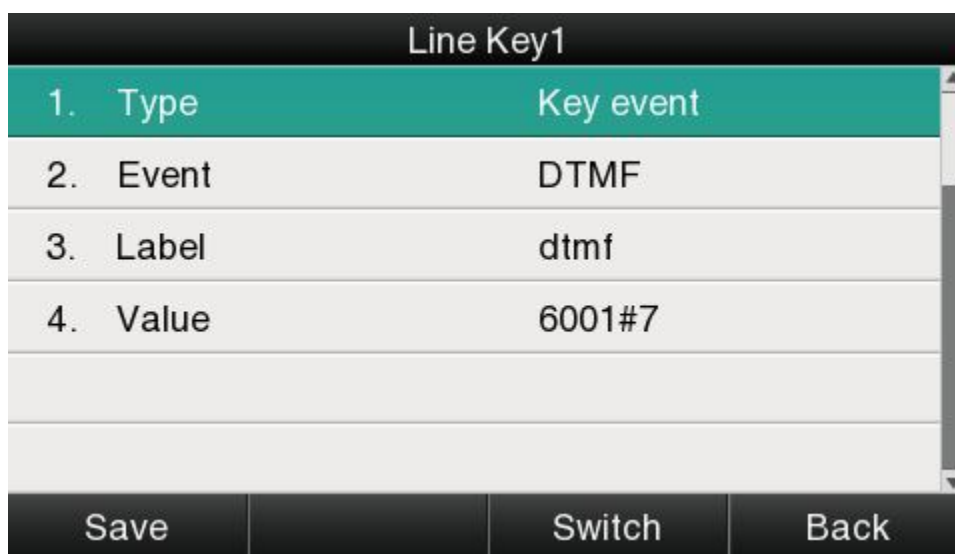

Item	Description
Label	To identify this key on LED, for example "DTMF".
Value	The value sent to remote end while on calling.

Directory



Press this key to access Directory.

The configuration item **Label** is a name to identify the key on LED, can be set as "phonebook".

Speed Dial

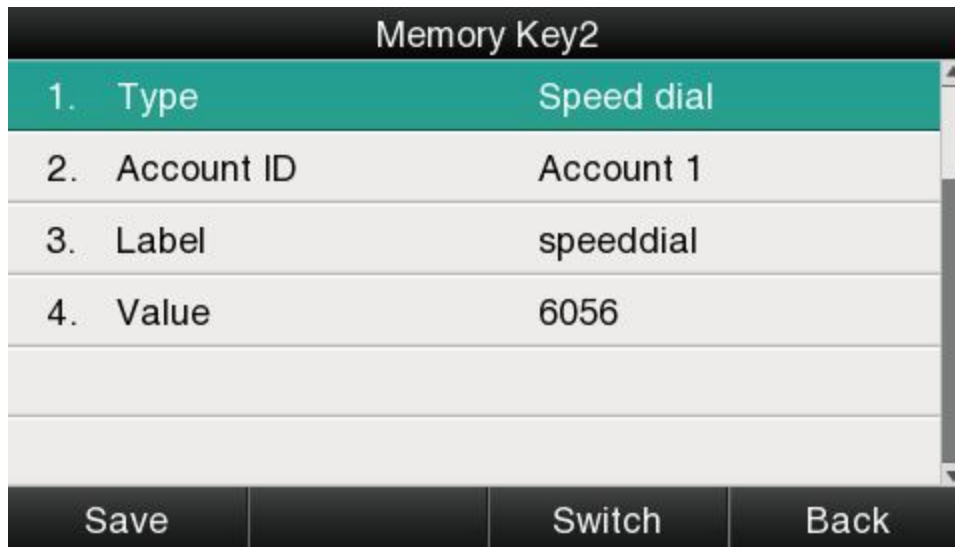
Press this key while standby state, the specified target phone number will be dial from the specified account.





Item	Description
Account ID	To display the account ID, press the soft key " Switch " or  ,  to modify, the optional value is Account 1 to 6.
Label	To identify this key on LED, for example "speeddial"
Value	The target phone number for speed dial

Intercom

Press this key when the phone is idle, the phone will dial the specified "Value", and the remote end will answer the call automatically.

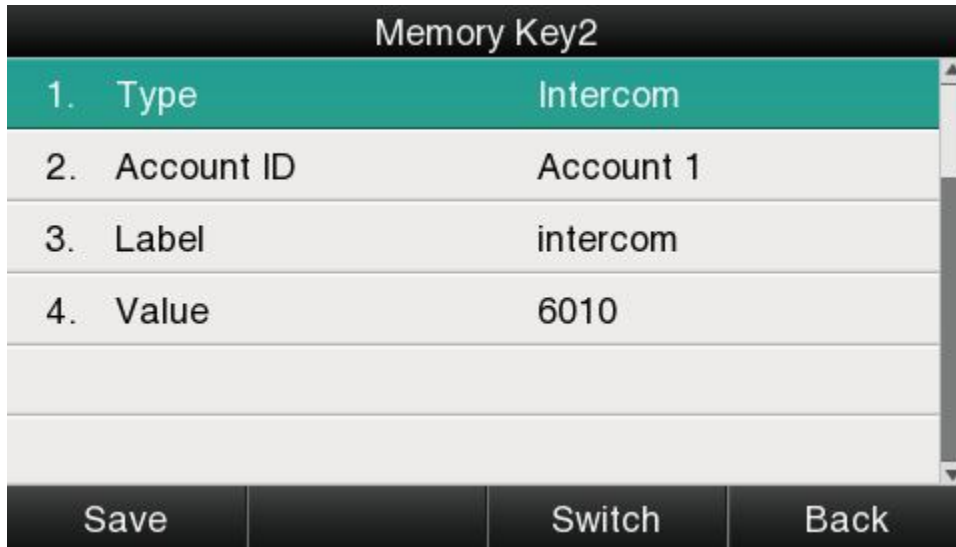
Note: This feature is supported by specified servers only.



Item	Description
Account ID	To display the account ID, press the soft key "Switch" or   to modify, the optional value is Account 1 to 6.
Label	To identify this key on LED, for example "intercom".
Value	The target phone number for Intercom

The programmable key configured via web included Memory Key, Line Key, Programmable Feature Key, and Feature key of expansion module.

atcom						
Basic Account Network DSS Key Phone Contacts						
Memory Key	Key	Type	Value	Label	Account	Extension
Line Key	DSS Key1	N/A			Auto	
Programmable Key	DSS Key2	Line			Account 1	
	DSS Key3	Speed Dial	6050	speed dial	Account 1	
EXT Key	DSS Key4	BLF	6049	BLF	Account 1	*8
	DSS Key5	Direct Picku	6048	call pickup	Account 1	
	DSS Key6	Call Park	700	call park	Account 1	
	DSS Key7	Intercom	6051	intercom	Account 1	
	DSS Key8	DTMF	6750#	DTMF	Auto	
	DSS Key9	Conference		conference	Auto	
	DSS Key10	Hold		hold	Auto	
	DSS Key11	DND		DND	Auto	
	DSS Key12	Redial		redial	Auto	
	DSS Key13	Directory		directory	Auto	
	DSS Key14	Call Return		call return	Auto	

Set Hotline Time-out(secs) via web: **Phone**→**Features**→**General Information**→**Hotline Time-out(secs)**.





7. Anonymous Call



This function includes making anonymous calls and blocking all anonymous calls.

If switch on the feature "Anonymous call", all outgoing calls will be displayed as an anonymous call in the remote end.

If switch on the feature "Rejection", all incoming anonymous calls will be blocked automatically.

Anonymous Call	
1. Accounts	Auto
2. Anonymous Call	Disable
3. Call On Code	
4. Call Off Code	
5. Rejection	Disable
6. Reject On Code	
Save	Switch
	Back

Item	Operation	Description
Accounts	press the soft key " Switch " or  、  to modify,	Select the Account for anonymous call.
Anonymous Call	press the soft key " Switch " or  、  to modify,	Switch on/off the feature of making anonymous calls.
Call On Code	The Number key, "*" key, and "# " are permitted to be input.	Set the feature code to turning on anonymous call, the phone enables anonymous call by sending the feature code to the server
Call Off Code	The Number key, "*" key, and	Set the feature code to turning off

	“#” are permitted to be input.	anonymous call, the phone disables anonymous call by sending the feature code to the server
Rejection	press the soft key “Switch” or  、  to modify	Switch on/off the feature of blocking anonymous calls.
Reject On Code	The Number key, “*” key, and “#” are permitted to be input.	Set the feature code to turning on anonymous call rejection, the phone enables anonymous call rejection by sending the feature code to the server
Reject Off Code	The Number key, “*” key, and “#” are permitted to be input.	Set the feature code to turning off anonymous call rejection, the phone disables anonymous call rejection by sending the feature code to the server

Set Anonymous Call via web: **Account**→**Basic**→**Select the Account**→**Anonymous Call**.

Set Anonymous Call Rejection via web: **Account**→**Basic**→**Select the Account**→**Anonymous Call Rejection**.

3.4.3、Directory

The content of Directory includes local phonebook and blacklist. Enter Directory as follow,

1. Press the soft key “Directory” when the phone is standby

2. Press the navigation key 

3. Press the menu key , and then select “Directory”

Configure the “Directory” via Web:

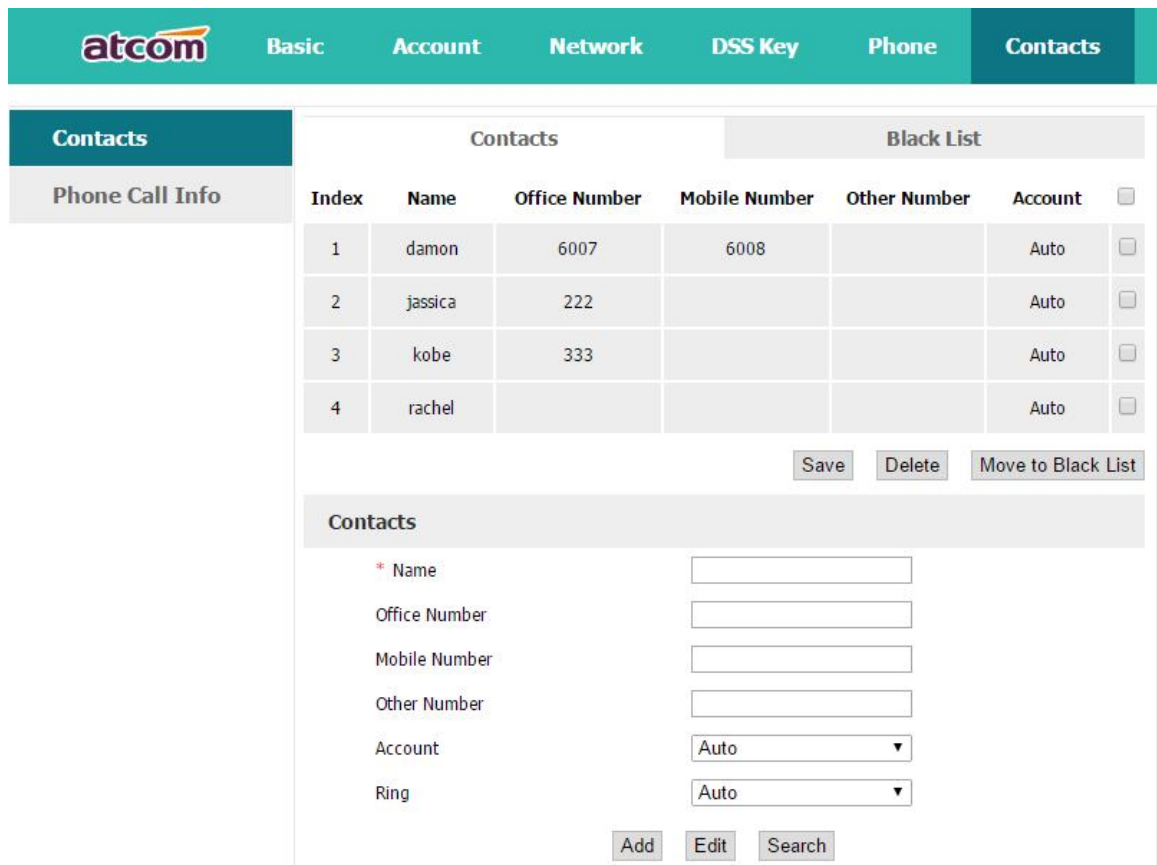

Contacts						Black List
Index	Name	Office Number	Mobile Number	Other Number	Account	<input type="checkbox"/>
1	damon	6007	6008		Auto	<input type="checkbox"/>
2	jassica	222			Auto	<input type="checkbox"/>
3	kobe	333			Auto	<input type="checkbox"/>
4	rachel				Auto	<input type="checkbox"/>

Save Delete Move to Black List

Contacts

* Name

Office Number

Mobile Number

Other Number

Account

Ring

Add Edit Search

All operations on Directory via Web will be not active until click "Save". When too much item existed in the Directory, it will be an easy way to search by keyword about name, Office Number, Mobile Number or other Number. The exactly matched item will be listed, otherwise you will be prompted "Not find the specified contact".

Local phonebook

Name and phone number are permitted to be saved into the local phonebook, and up to 400 items. It's able to add new contact, edit or delete exist contact or dial, also move the item to blacklist.

Make calls from directory

Path to set on the phone:  → **Directory** → **Local Contacts** → **Select the record** → **Dial**.

If only one phone number saved with the selected contact person, the phone number will be dialed while calling the contact person.







If multiple phone numbers saved with the selected contact person, user must select one of the phone numbers for dialing while calling the contact person.



Add new contact

Path to add new contact on the phone: Press  → **Directory** → **Local Contacts** → **Add**.

Anonymous Call	
1. Accounts	Auto
2. Anonymous Call	Disable
3. Call On Code	
4. Call Off Code	
5. Rejection	Disable
6. Reject On Code	
Save	Switch
	Back

Item	Operation	Description
Name	Input by number keys, "*" or "#" key, change the input-method via pressing the soft key "abc"	It's used to identify different phone numbers. Any reduplicated names are not permitted in the directory.
Office	Input by number keys, "*" or "#" key, change the input-method via pressing the soft key "abc"	You can save three numbers at most. While calling a contact person in directory, the phone will redirect to the page that to select one number to dial when multiple numbers are saved for one contact record
Mobile		
Other		
Account	Press the key  、  or the soft key "Switch" to modify the account ID.	It's used to bundle each item with the corresponding account, and the optional value is "Auto" or "Account 1" to "Account 6". "Auto" means the 1 st available account will be selected.
Ring	Press the key  、  or the soft key "Switch" to modify the account ID.	It's used to bundle each item with the corresponding ringtone, and the optional value is "Auto" or "Ringtone 1" to "Ringtone 10". "Auto" means the default ringtone will be played if new incoming call happened, otherwise the selected ringtone will be played.
Photo	Only for preview. It's available for modification via Web only.	To identify a contact item by a specified image.

Add new contact via web: **Contacts→Contacts→Input messages→Add→Save.**

Edit the contact

User must re-edit the contact item while updating one item of local phonebook.

Path to edit the contact on the phone: **Press  →Directory→Local Contacts→Select the item to edit→Option→Edit→OK.**



Edit the contact item via Web: **Contacts→Contacts→click on the item to edit→modify messages→Click "Edit"→Click "Save".**

Delete the contact

Path to delete the contact on the phone: **Press  →Directory→Local Contacts→Select the item to delete→Option→Delete→OK→OK.**

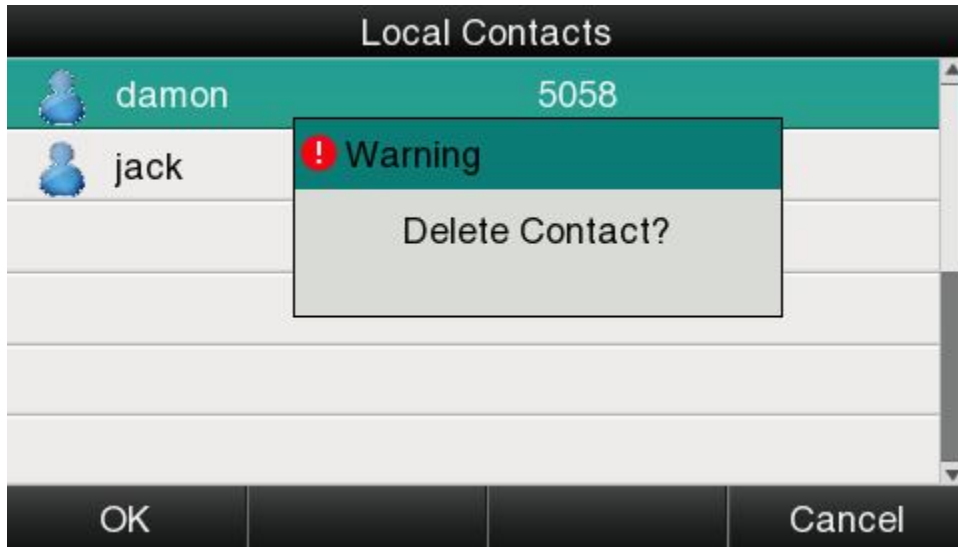

Press the soft key **"Cancel"** at the Warning UI to stop deleting.

Delete the contact item via web: **Contacts**→**Contacts**→**Select the item to delete**→**Click on "Delete"**→**Click on "Save"**.

Move to blacklist

Path to move to blacklist on the phone: Press  → **Directory**→**Local Contacts**→**Select the item to move**→**Option** →**Move to Blacklist** →**OK**→**OK**.

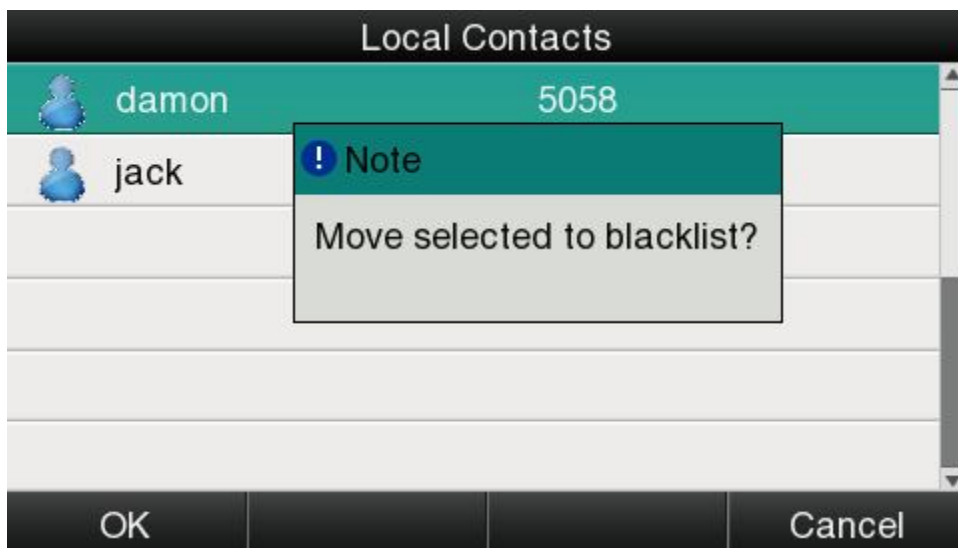

Press the soft key **"Cancel"** at the Warning UI to stop this operation.

Move the contact item to blacklist via web : **Contacts**→**Contacts**→**Select the item to move to blacklist**→**Click on "Move to black List"**→**Click on "Save"**.

Blacklist

The purpose of blacklist's feature is to block the phone number inside blacklist to call the host phone number, but it's available for the hosted phone number to call any phone number in the black list.

The most operation of blacklist is the same as local phonebook except for the feature "Move to Contacts", it means moving an item of blacklist to local phonebook to resume the phone number to dial the host phone number normally.

Remote phonebook

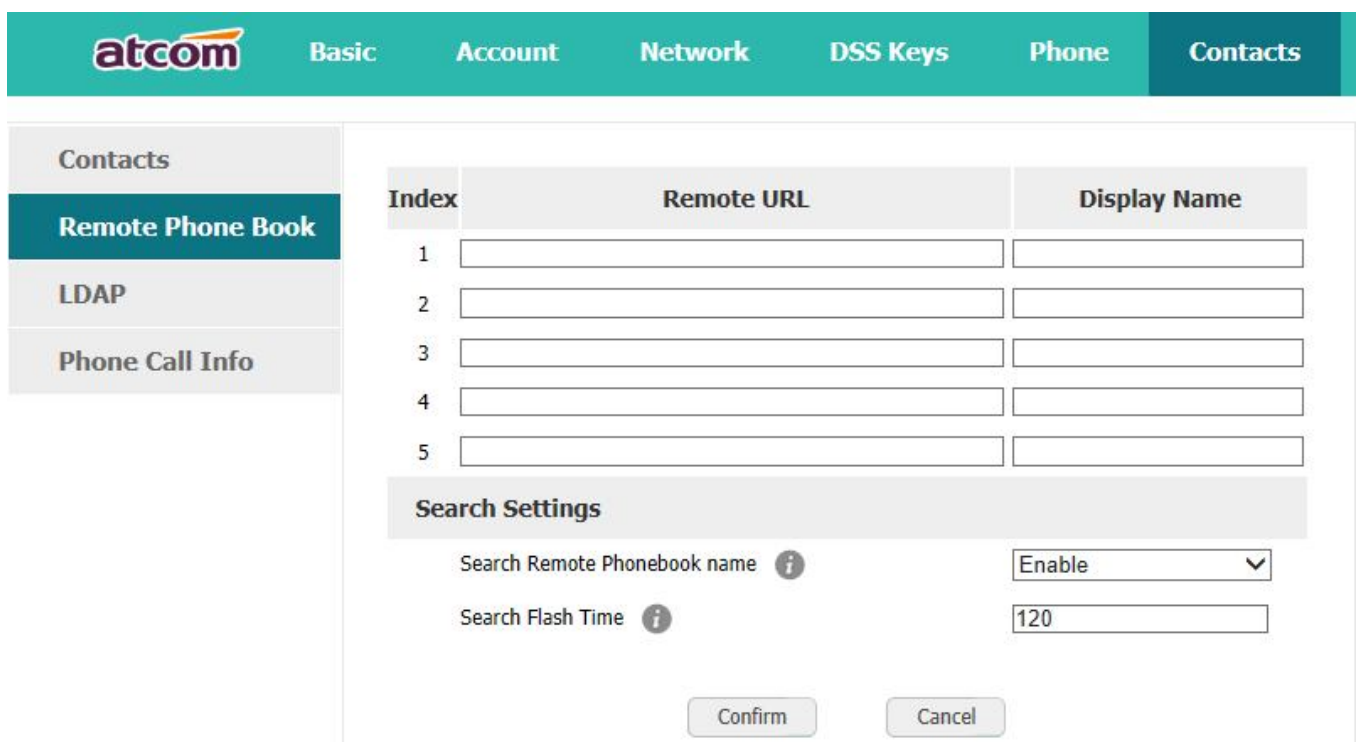

Index	Remote URL	Display Name
1	<input type="text"/>	<input type="text"/>
2	<input type="text"/>	<input type="text"/>
3	<input type="text"/>	<input type="text"/>
4	<input type="text"/>	<input type="text"/>
5	<input type="text"/>	<input type="text"/>

Search Settings

Search Remote Phonebook name i

Search Flash Time i















1. Remote URL: Set a remote phonebook download path.Support the TFTP,FTP,HTTP and HTTPs server.

2. Display name: Set a display name on the phone.

3. Search Remote Phonebook name:Select "Yes" or "No" to enable or disable search remote phonebook name.

4. Search Flash Time: Set the search flash time.Defaults to 120.

LDAP

LDAP 	
Enable LDAP	<input type="text" value="Disable"/>
LDAP Name Filter	<input type="text"/> 
LDAP Number Filter	<input type="text"/> 
Server Address	<input type="text"/> Port <input type="text" value="389"/> 
Base	<input type="text"/> 
Username	<input type="text"/> 
Password	<input type="text"/> 
Max Hits	<input type="text" value="50"/>  (1~32000)
LDAP Name Attributes	<input type="text"/> 
LDAP Number Attributes	<input type="text"/> 
LDAP Display Name	<input type="text"/> 
Protocol	<input type="text" value="Version 3"/>
LDAP Sorting Results	<input type="text" value="Disable"/> 
LDAP Lookup For Incoming Call	<input type="text" value="Disable"/> 
LDAP Lookup For dialing	<input type="text" value="Disable"/> 



1. Enable LDAP: Select "Yes" or "No" to enable or disable LDAP.
2. LDAP Name Filter: Set the name of the LDAP search attributes.
3. LDAP Number Filter: Set the number of the LDAP search attributes.
4. Server Address: Set the LDAP server domain name or IP address.
5. Port: Set the LDAP server port number. Defaults to 389.
6. Base: Set the LDAP search base.
7. Username: Set the LDAP server username.
8. Password: Set the LDAP server password.
9. Max Hits(1~32000): Set the maximum number of search results from the LDAP server.

10. LDAP Name Attributes: Set the name of the attributes returned from the server.
11. LDAP Number Attributes: Set the number of the attributes returned from the server.
12. LDAP Display Name: The contact record the name of the displayed on the LCD.
13. Protocol: Set the phone to support LDAP protocol version. Defaults to version 3.
14. LDAP Sorting Results: Set the phone to sort the search results.
15. LDAP Lookup For Incoming Call: Set the phone for LDAP search when incoming call.
16. LDAP Lookup For dialing: Set the phone for LDAP search when dialing,

3.4.4. History

It includes the dialed, answered, missed and transferred items, maximum 400 items.

User is able to review or delete any item of the history on the phone. And enter "History" in below ways:

1. Press the key 
2. Press the key , then select "History"
3. Press the soft key "History" while phone is under standby status

When any operations above is done, details info of all recent history will be listed on LCD display, include the type of each item, the name of contact person, date and time.

Also, user is able to check the detail info of call history via Web, but only review operation is allowed while accessing via web.

atcom				
Basic Account Network DSS Keys Phone Contacts				
Contacts				
Remote Phone Book				
LDAP				
Phone Call Info				
	Dialed List	Missed List	Received List	Forwarded List
	Index	Datetime	Local Identity	Name
				Tel Number
	1	2016/1/13 10:46	5030@172.16.0.240:5060	5001
				5001@172.16.0.240
	2	2016/1/13 10:45	5030@172.16.0.240:5060	5031
				5031@172.16.0.240
	3	2016/1/13 10:45	5030@172.16.0.240:5060	5002
				5002@172.16.0.240

Make calls from history

Path to make calls from history on the phone: **Enter history UI**→**Select the item to dial**→**Dial**.



Delete one item from history

Path to delete one item from history on the phone: **Enter history UI**→**Select the item to delete**→**Delete**.

Check the details of history

Path to check the details of history on the phone: **Enter history UI**→**Select the item to check**→**Option**→**Detail**→Press  or "OK".

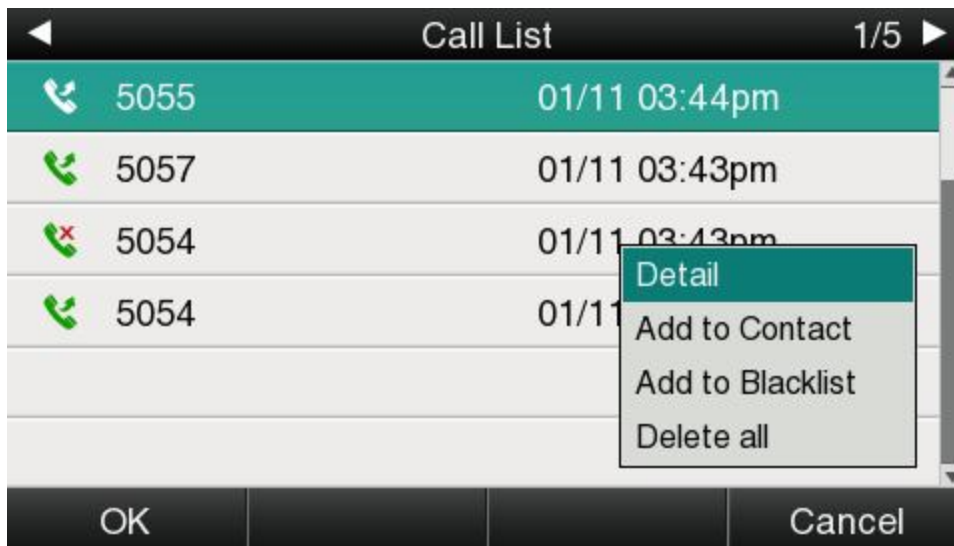

Add to Contact

1. **Enter "Call History"**→**Select the target item**→**Option**→**add to Contact**→**Press the key**  **or soft key "Confirm"**.



At this moment an "edit" page will be popped up.

Add to Contact	
1. Name	5055
2. Office	5055
3. Mobile	Old Number
4. Other	Old Number
5. Account	Auto
6. Ring	Auto

Save abc Delete Back

The item of "Office", "Mobile" and "Other" are able to be switched over between "Old Number" and current number. If the being operated item had been saved already in the directory, "Old Number" will be the previous value, otherwise "Old Number" will be null. The UI page of "Add to Blacklist" is the same as above.

2. **Modify the contact name, phone number and ringtone.**

3. **Press the key  or soft key "Saved" to save the modification, press the key  or soft key "Cancel" to Cancel the modification.**

Add to Blacklist

For more info about this operation, please refer to [Add to Contact](#).

Delete all History's records

Path to delete all history's records on the phone: **Enter History UI**→**Option**→**Delete all**→

Press  or "OK".

3.4.5. Message

User will benefit from the feature of voicemail when they're not available to answer an incoming call or missed some incoming calls. However this feature must be supported by Server. Voicemail must be set up before using it.

Set the voicemail via Web: **Account**→**Basic**→**Select an account to configure**→**Voice Mail**.



Sometimes the voicemail push can't be reached in time, because the configuration problem with Server, you must configure some related parameter via Web to make the phone automatically send its request to Server for getting voicemail info.

Set "Subscribe for MWI" via web: **Account**→**Advanced**→**Subscribe for MWI**.

Set "MWI Subscription Period(secs)" via web: **Account**→**Advanced**→**MWI Subscription Period(secs)**.

Set Voice Mail

There is 3 different methods to set up the voicemail,

1. Press the key  after factory set
2. Press the key  for a while
3. Press the key  →Select "Message"→Setup Voicemail



ViewVoice Mail

User is able to check voicemail in below ways:

1. **Setup voicemail number**→**Press the key** 
2. **Press the key** →**Select "Message"→"View Voicemail"**

View Voice Mail		
1.	5025	0 new 0 old mail
2.	Account 2	Unregistered
3.	Account 3	Unregistered
4.	Account 4	Unregistered
5.	Account 5	Unregistered
6.	Account 6	Unregistered
Connect		Back

Select the account with "N new N old mail", and press the soft key "Connect", the corresponding voicemail will be connected.

Select the account with "Unregistered", and press the soft key "Connect", the setting page of Voicemail will be popped up.

3.4.6. Settings

Basic settings and Advanced settings will be introduces in this part,

Basic Settings

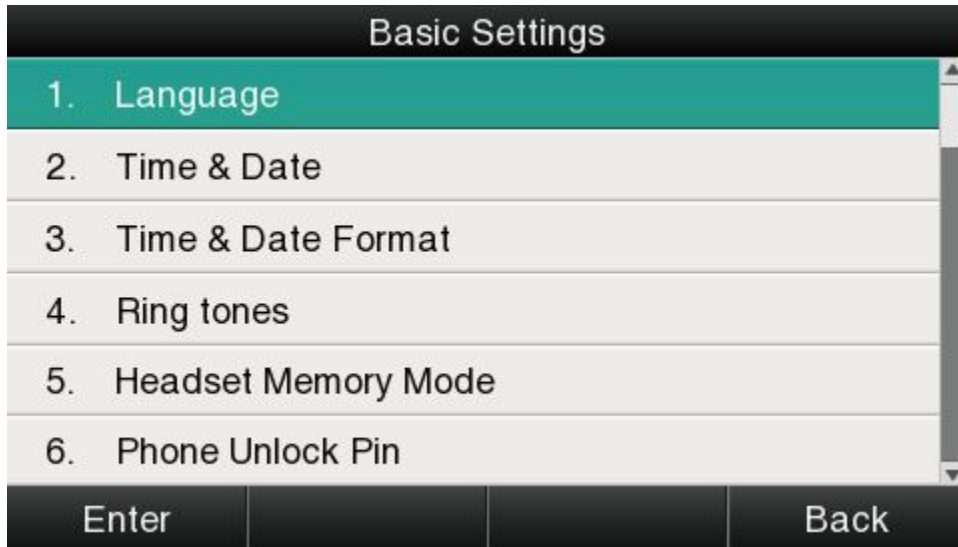

1. Language

A68(W) supports multiple language, to modify the language, please press the key  →

Setting → **Basic setting** → **Language** → **Select the target language and press the soft key "Save"**.



Set language via web: There is a drop-down box at the top left corner of webpage, choice one kind of language and click, the language will take effect immediately.

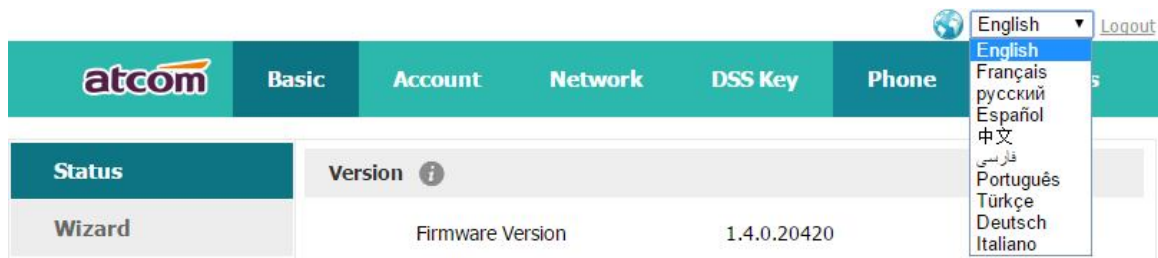



2. Time &Date



Time & Date will be displayed at the standby page of A68(W), and these info will be related with all process of IP phone. "Time & Date" can be gained by NTP Server automatically or set manually.

NTPSetting



Path to set on the phone: Press  → **Settings** → **Basic Settings** → **Time & Date** → **NTP Settings**.



Item	Operation	Description
Time Zone	Press the key  、  or soft key " Switch " to modify it.	Select the correct Time Zone for the IP phone.

NTP Server	Key in the IP address of domain name by the number keys,"*", "#"	Specify the NTP Server
Secondary NTP Server	Key in the IP address of domain name by the number keys,"*", "#"	Specify the standby NTP Server
Daylight-Saving Time	Press the key  、  or soft key" Switch" to modify it.	Optional: "Off", "Auto" or "Manual". And "Manual" mean user must set this via web.

Set NTP via Web: **Phone**→**Preference**.

Time Zone	<input type="text" value="+8 China(Beijing)"/>	
Primary NTP Server	<input type="text" value="pool.ntp.org"/>	
Secondary NTP Server	<input type="text" value="time.windows.com"/>	
Update Interval(secs)	<input type="text" value="1000"/>	
daylight	<input type="text" value="Disable"/>	
Fixed Type	<input checked="" type="radio"/> By Date <input type="radio"/> By Week	
Start Month	<input type="text" value="January"/>	
Start Date	<input type="text" value="1"/>	
Start Hour of Day	<input type="text" value="0"/>	
Start Day of Week	<input type="text" value="Sunday"/>	
Start Week of Month	<input type="text" value="First In Month"/>	
Stop Month	<input type="text" value="January"/>	
Stop Date	<input type="text" value="1"/>	
Stop Hour of Day	<input type="text" value="0"/>	
Stop Day of Week	<input type="text" value="Sunday"/>	
Stop Week of Month	<input type="text" value="First In Month"/>	
Offset(minutes)	<input type="text" value="0"/>	

Item	Operation	Description
Time Zone	Click drop-down box to select	Set a time zone matches condition

Primary NTP Server	Manual input	The primary NTP server that provide time and date
Secondary NTP Server	Manual input	The secondary NTP server that provide time and date
Update Interval(secs)	Manual input	The interval that the phone gains time and date from NTP server
Daylight	Click drop-down box to select	A switch to control the status that whether to enable the daylight or not
Fixed Type	Radio content	Daylight fixed type, only the specified items are configurable
Start Month	Click drop-down box to select	The month that the daylight rule begins taking effect
Start Date	Manual input	The day that the daylight rule begins taking effect
Start Hour of Day	Manual input	The hour of day that the daylight rule begins taking effect
Start Day of Week	Click drop-down box to select	The day of week that the daylight rule begins taking effect
Start Week of Month	Click drop-down box to select	The week of month that the daylight rule begins taking effect
Stop Month	Click drop-down box to select	The month that the daylight rule stops taking effect
Stop Date	Manual input	The day that the daylight rule stops taking effect
Stop Hour of Day	Manual input	The hour of day that the daylight rule stops taking effect
Stop Day of Week	Click drop-down box to select	The day of week that the daylight rule stops taking effect
Stop Week of Month	Click drop-down box to select	The week of month that the daylight rule stops taking effect
Offset(minutes)	Manual input	The offset time that daylight rule takes effect

Manual Settings

Path to set on the phone: Press  → **Settings** → **Basic Settings** → **Time & Date** → **Manual Settings**.

Manual Settings	
1. Year	2016
2. Month	01
3. Day	07
4. Hour	10
5. Minute	45
6. Second	11
Save	123
Delete	Back

Item	Operation	Description
Year	Key in "Year" with the number key, "*" and "#"	Date info
Month	Key in "Month" with the number key, "*" and "#"	
Day	Key in "Day" with the number key, "*" and "#"	
Hour	Key in "Hour" with the number key, "*" and "#"	Time info
Minute	Key in "Minute" with the number key, "*" and "#"	
Second	Key in "Second" with the number key, "*" and "#"	

Set the Time & Date manually via web: **Phone** → **Preference**.

Manual Time Disable ▼ ⓘ

Date Generated Date

Time Generated Time

Item	Operation	Description
Manual Time	Click the drop-down box to select	A switch to control the status whether to enable the manual time or not
Date	Manual input, click "Generated Date" to gains date from the computer	Set date manually
Time	Manual input, click "Generated Time" to gains time from the computer	Set time manually

3. Time&Date Format

Path to set on the phone: Press  → **Settings** → **Basic Settings** → **Time & Date Format**.



Item	Optional	Example of result
------	----------	-------------------

Clock	12 hour	03:30pm
	24 hour	15:30
Date	WWW MMM DD	TuesdayOct.16
	DD-MMM-YY	16-Oct.-14
	YYYY-MM-DD	2014-10-16
	DD/MM/YYYY	16/10/2014
	MM/DD/YY	10/16/14
	DD MMM YYYY	16,Oct.,2014
	WWW DD MMM	Tuesday,16,Oct.



Set the Time &Date Format via Web: **Phone**→**Preference**

4. Ringtones

10 different ringtones have been provided by A68(W) for selection. Path to set on the phone:

Press the key  → **Settings**→**Basic Settings**→**Ringtones**.



For the selected ringtone, there is a dot inside the circle. Press the key 、 to select other ringtone for playing.

Set ringtones via Web: **Account**→**Basic**→**Ring tones**.

5. Headset Memory Mode

Headset memory mode can be used to control the default device to make or answer calls. This function is disabled by default, which means the phone will communicate with others by hand-free when pre-dial or making calls from history or directory, and so is the situation that pressing "Answer" soft key to accept an incoming call. Once this function is enabled, the phone will make or answer calls by headset. Long press  can change the status of the "Headset Memory Mode".

This function can be configured on the phone only: Press  → **Settings**→**Basic Settings**→**Headset Memory Mode**.

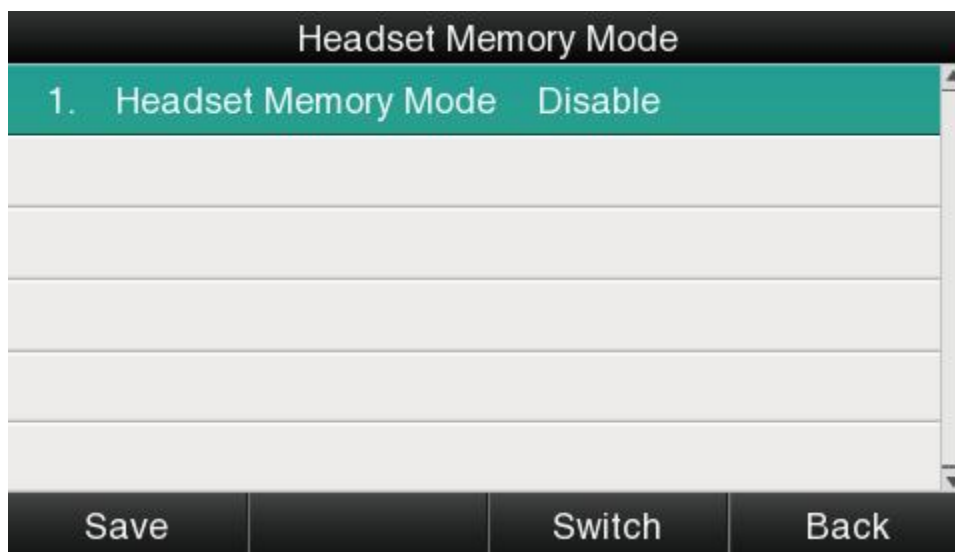

6. Phone Unlock PIN

Phone Unlock PIN: Unlock the phone locked conditions.



Item	Operation	Description
Current PIN	Manual input	Input the phone current PIN
New PIN	Manual input	Set the new PIN
Confirm PIN	Manual input	Confirm the new PIN

Advanced Settings

Password will be requested while accessing the page of "Advanced Settings". This password is the same as the user's ("admin") to access.

1. Accounts

Up to 6 accounts supported by A68(W), path to set the account info on phone: **Press**



→ **Settings** → **Advanced Settings** → **Input password** → **Accounts**.



Status	Description
Empty	The account has not been configured yet
Registered	The account has been registered already
Register Failed	The account is register failed
Disabled	The account is disabled

Select the account and press the soft key "**Enter**" to access the page of account setting.

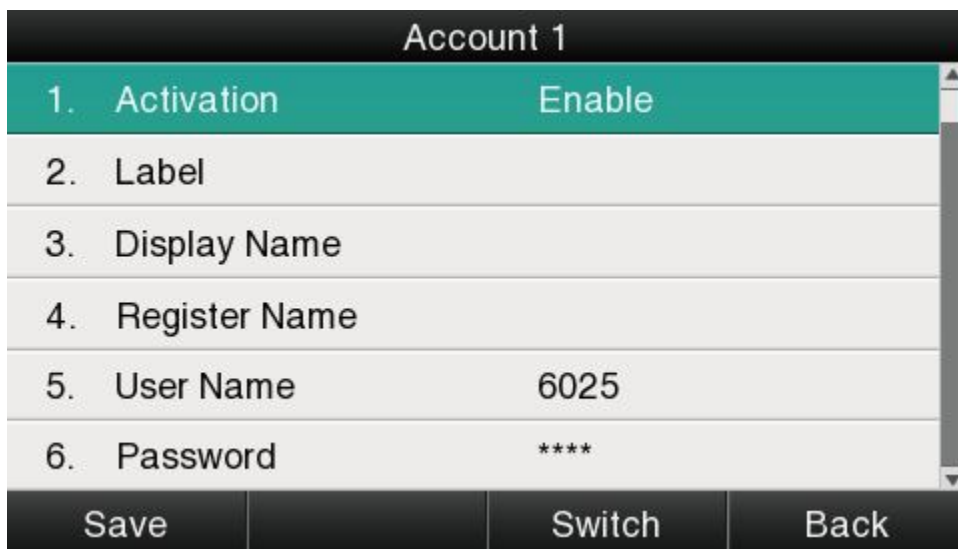

Item	Description
Activation	The status of account, the default is "Enable", if set this as

	"Disable",the account will be forbidden.
Lable	It will show on the phone, can skip this item
Display Name	Parameter that in the SIP, if the SIP Server is supportable, this name will show on the phone of callee
Register Name	The register ID, supplied by SIP Server, can skip this item
User Name	Account ID
Password	Password for account
SIP Server	The address that accounts needed to register from
Outbound Status	The status of Outbound Server, "off" by default
Outbound Proxy	IP address of Outbound Agency
Stun Status	The status of Stun Server, "off" by default
Stun Server	IP address of Stun Server

Configure account via web: **Account**→**Basic**

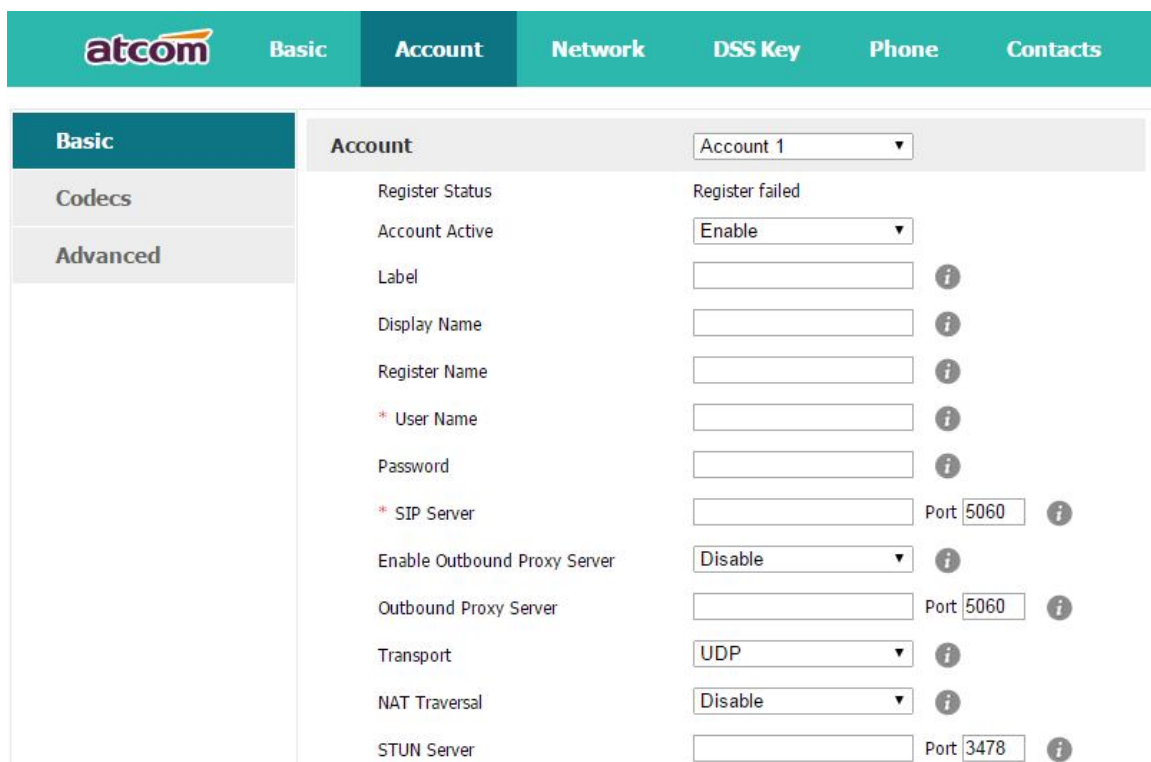

The screenshot displays the ATCOM web interface for configuring an account. The top navigation bar includes tabs for Basic, Account, Network, DSS Key, Phone, and Contacts. The 'Account' tab is selected, and the 'Basic' sub-tab is active. The configuration page shows the following fields and values:

- Account:** Account 1 (dropdown)
- Register Status:** Register failed
- Account Active:** Enable (dropdown)
- Label:** (empty text field)
- Display Name:** (empty text field)
- Register Name:** (empty text field)
- * User Name:** (empty text field)
- Password:** (empty text field)
- * SIP Server:** (empty text field) Port 5060
- Enable Outbound Proxy Server:** Disable (dropdown)
- Outbound Proxy Server:** (empty text field) Port 5060
- Transport:** UDP (dropdown)
- NAT Traversal:** Disable (dropdown)
- STUN Server:** (empty text field) Port 3478

2. Set Password

The password for Advanced Settings also is used for Web access as the role "admin". Path to set password on phone: Press  → **Settings** → **Advanced Settings** → **Input password** → **Set Password**.



Item	Description
Current PWD	The current password for web access as the role of "admin", it's "admin" by default.
New PWD	To set the new password, blank is acceptable.
Confirm PWD	Input the new password again, to confirm the new password.

Set password via Web: **Phone** → **Security**.

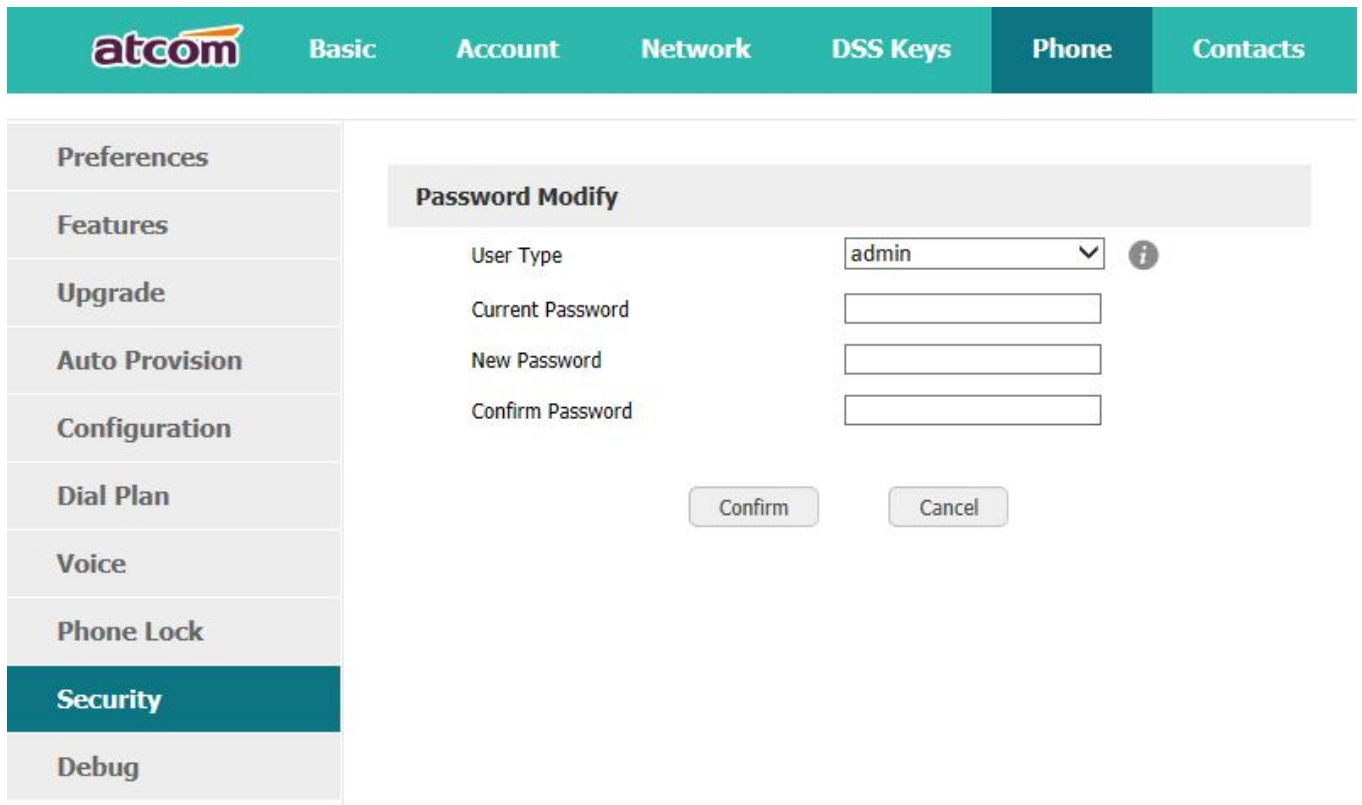

The screenshot shows the atcom web interface with a teal header containing the logo and navigation tabs: Basic, Account, Network, DSS Keys, Phone, and Contacts. On the left is a vertical sidebar menu with options: Preferences, Features, Upgrade, Auto Provision, Configuration, Dial Plan, Voice, Phone Lock, Security (highlighted in teal), and Debug. The main content area displays the 'Password Modify' form, which includes a dropdown menu for 'User Type' (set to 'admin'), three text input fields for 'Current Password', 'New Password', and 'Confirm Password', and two buttons: 'Confirm' and 'Cancel'.

3. Network

Path to set network parameters on phone: **Press**  **→ Settings → Advanced Settings → Input the password → Network.**

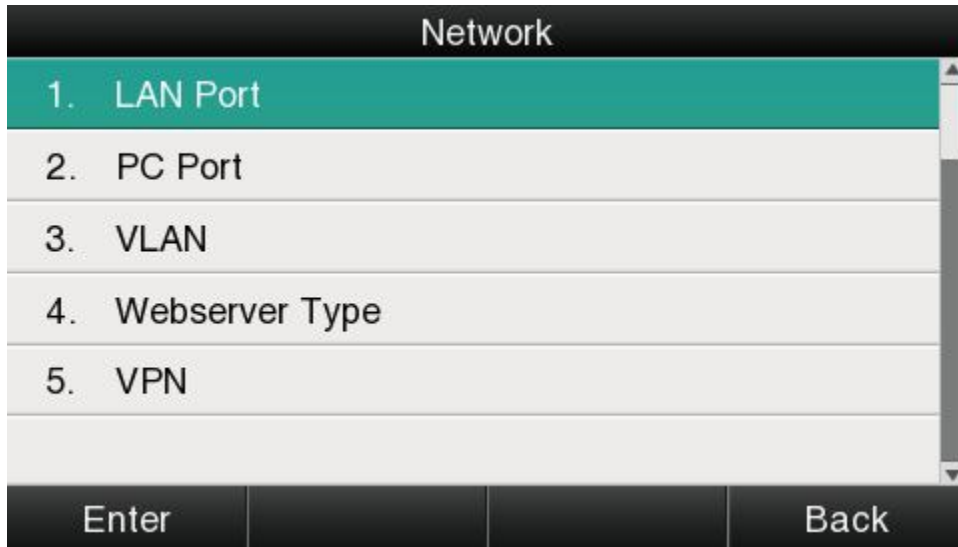

➤ LAN Port

Connect the phone with local network via LAN port, to gain IP address in 3 ways: DHCP, Static, PPPoE. Set the LAN port via Web: **Network**→ **Basic**.

DHCP

The phone gains IP address via DHCP by default.

STATIC IP

If the phone gains IP address via Static IP, user must input the IP address info manually.



PPPoE

If the phone gains IP address via PPPoE, user must input username/password of PPPoE, and PPPoE server or ISP support will be requested in this way.

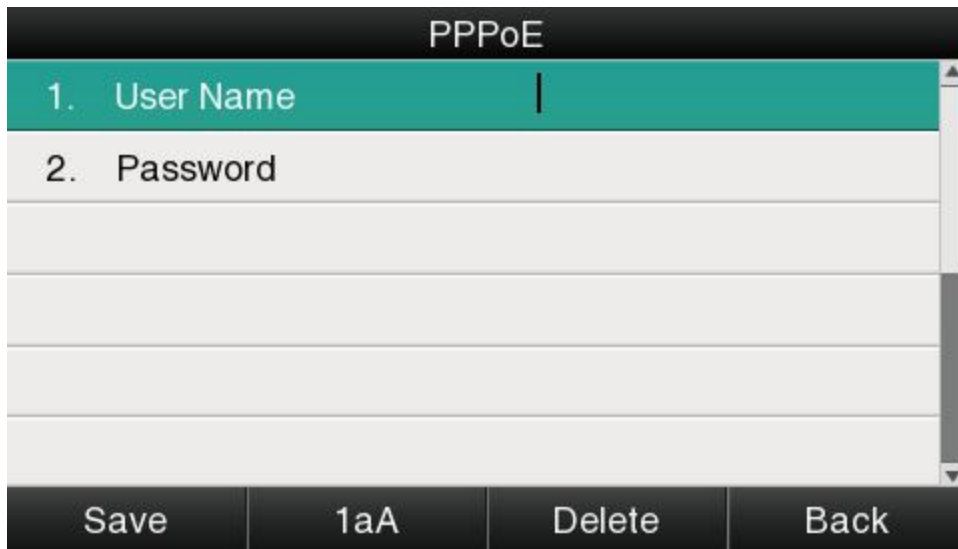

PPPoE

1. User Name |

2. Password

Save 1aA Delete Back

➤ **PC Port**

Only bridge mode support by PC port.



PC Port

1. Bridge

Back

➤ **VLAN**

The feature of VLAN must be supported by network switch, and by default this feature it's not activated on Rainbow 4(s).

VLAN	
1. LAN Status	Disable
2. LAN VID Number	0
3. LAN Priority	0
4. PC Status	Disable
5. PC VID number	0
6. PC Priority	0

Save Switch Back

Set the VLAN via Web: **Network** → **Advanced** → **VLAN**.

➤ **Webserver Type**

Webserver type include HTTP and HTTPS, different access port will be required by different access type, user is able to confirm the port info at the webpage, HTTP & HTTPS are both permitted by default.

Webserver Type	
1. Webserver Type	Disabled

Save Switch Back

Set Webserver type via Web: **Network** → **Advanced** → **WebServer** → **Type**.

➤ **VPN**

A68(W) support the feature of VPN, and this feature must be supported by VPN Server.

VPN	
1. VPN Status	Disabled
2. VPN Type	L2TP_TUNNEL
3. VPN Server	
4. User Name	
5. Password	
<div style="display: flex; justify-content: space-between; width: 100%;"> Save Switch Back </div>	

Set the VPN via Web: **Network** → **Advanced** → **VPN**.

4. Keypad Lock

Keypad Lock	
1. Keypad lock enable	Disabled
2. Keypad lock type	Menu key
3. Keypad lock timeout	10
4. Unlock before	Disabled
<div style="display: flex; justify-content: space-between; width: 100%;"> Save Switch Back </div>	

atcom		Basic	Account	Network	DSS Keys	Phone	Contacts
Preferences							
Features							
Upgrade							
Auto Provision							
Configuration							
Dial Plan							
Voice							
Phone Lock							
Security							
Debug							

Phone Lock	
Keypad Lock Enable	Disable ▾
Keypad Lock Type	Menu Key ▾
Phone Unlock PIN(0~15 Digit)	...
Phone Lock Time Out(0~3600s)	10
Emergency	110,120,119,911 i
<input type="button" value="Confirm"/> <input type="button" value="Cancel"/>	

1. Keypad Lock Enable: select "Yes" or "No" to enable or disable keypad lock
2. Keypad Lock Type: Menu key/Function keys/All keys/Answer call only.Defaults to Menu key.
3. Phone Unlock PIN(0~15 Digit):set the phone unlock PIN.Range: 0~15 digit.
4. Phone Lock Time Out(0~3600s): set the phone lock time out.Range: 0~3600s
5. Emergency:set emergency number.Defaults to 110、120、119 and 911.

5. Reboot

After the restart,the phone will back to standby interface.



6. Reset to factory

Once reset to factory, all parameter settings will back to the factory default value, and all configuration will be cleared, users must be careful on this.



Reset Option: **Full Reset**, **Config Reset** and **UserData Reset**.



Reset to factory via Web: **Phone**→**Upgrade**→**Reset to Factory**.

3.4.7、Display



For more convenient, users are able to adjust the contrast grade and backlight of the main LCD display and the BLF LCD display.



1、Wallpaper



There are 5 different wallpapers for options,press the soft key "**Switch**" or the key 、 for modification.

2、Slave Contrast

There are 9 different contrast grades for options,press the soft key "**Switch**" or the key ,
 for modification,6 is the default value.



3. Slave LCD Mode

There are 2 different modes for options, press the soft key "**Switch**" or the key  ,  for modification, defaults to Mode2.



4. Backlight

Backlight is the brightness of LCD, also it has been defined as 9 different grades. The number "9" means the lightest.



To adjust the brightness of LCD expansion module, it must be connected with the hosted phone. Otherwise the host phone will indicated "No expansion module".

5. Screensaver

The phone is not operating within the given time, automatically enter the screensaver interface.



4、Advanced Feature

4.1、Codecs

A68(W) support multiple codecs, users can select the codes via Web.

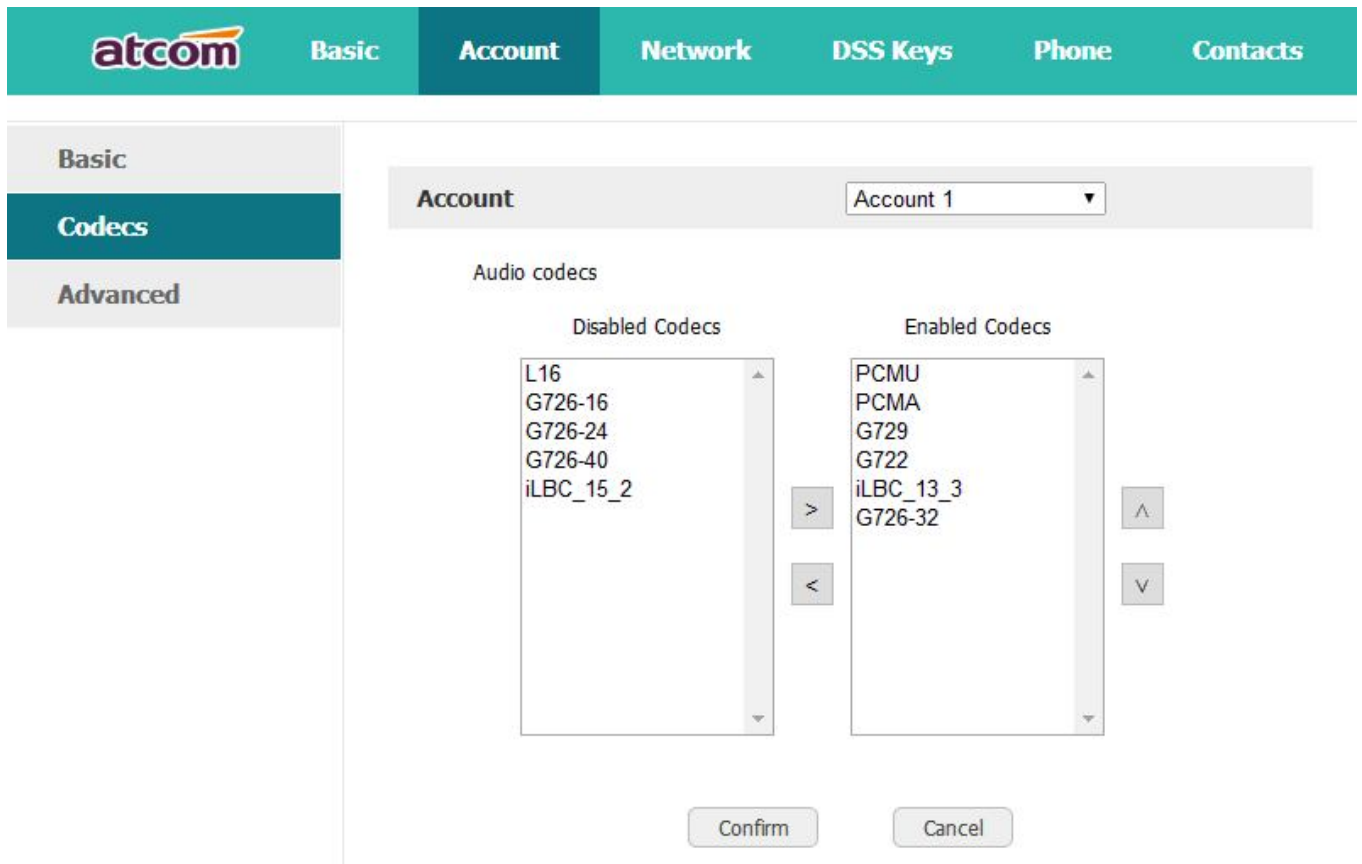

The screenshot shows the ATCOM web interface for configuring audio codecs. The navigation menu includes 'Basic', 'Codecs', and 'Advanced'. The 'Account' dropdown is set to 'Account 1'. Under 'Audio codecs', there are two columns: 'Disabled Codes' and 'Enabled Codes'. The 'Disabled Codes' list includes L16, G726-16, G726-24, G726-40, and iLBC_15_2. The 'Enabled Codes' list includes PCMU, PCMA, G729, G722, iLBC_13_3, and G726-32. Between the lists are '>' and '<' buttons. To the right of the 'Enabled Codes' list are '^' and 'v' buttons. At the bottom are 'Confirm' and 'Cancel' buttons.

> means to enable the item of “Disabled Codes” , < means to disable the item of “EnabledCodes” ; click the button ^ or v to sort all enabled codes, the top item has the highest priority.

Note: Multiple different items of G726, iLBC should not activated simultaneously.

4.2、 Capture and Upgrading

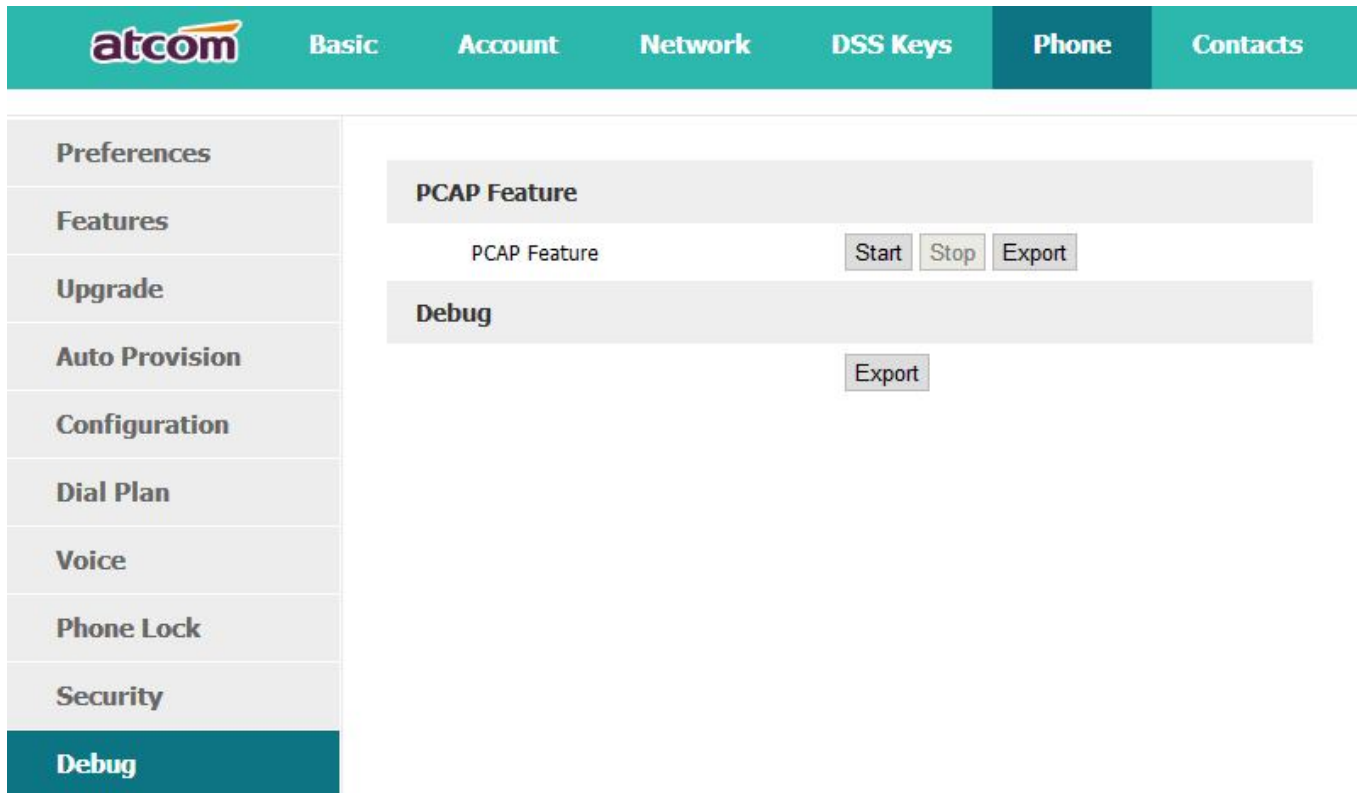

The screenshot displays the atcom web interface. At the top, there is a teal navigation bar with the atcom logo on the left and menu items: Basic, Account, Network, DSS Keys, Phone, and Contacts. Below this is a vertical sidebar menu with items: Preferences, Features, Upgrade, Auto Provision, Configuration, Dial Plan, Voice, Phone Lock, Security, and Debug (which is highlighted in a darker teal). The main content area shows two sections: 'PCAP Feature' and 'Debug'. The 'PCAP Feature' section contains a label 'PCAP Feature' and three buttons: 'Start', 'Stop', and 'Export'. The 'Debug' section contains an 'Export' button.

Click the button “ Start” to start the capture and click the button “Stop” to end the capture. Then click the button “export” to download the capture file.

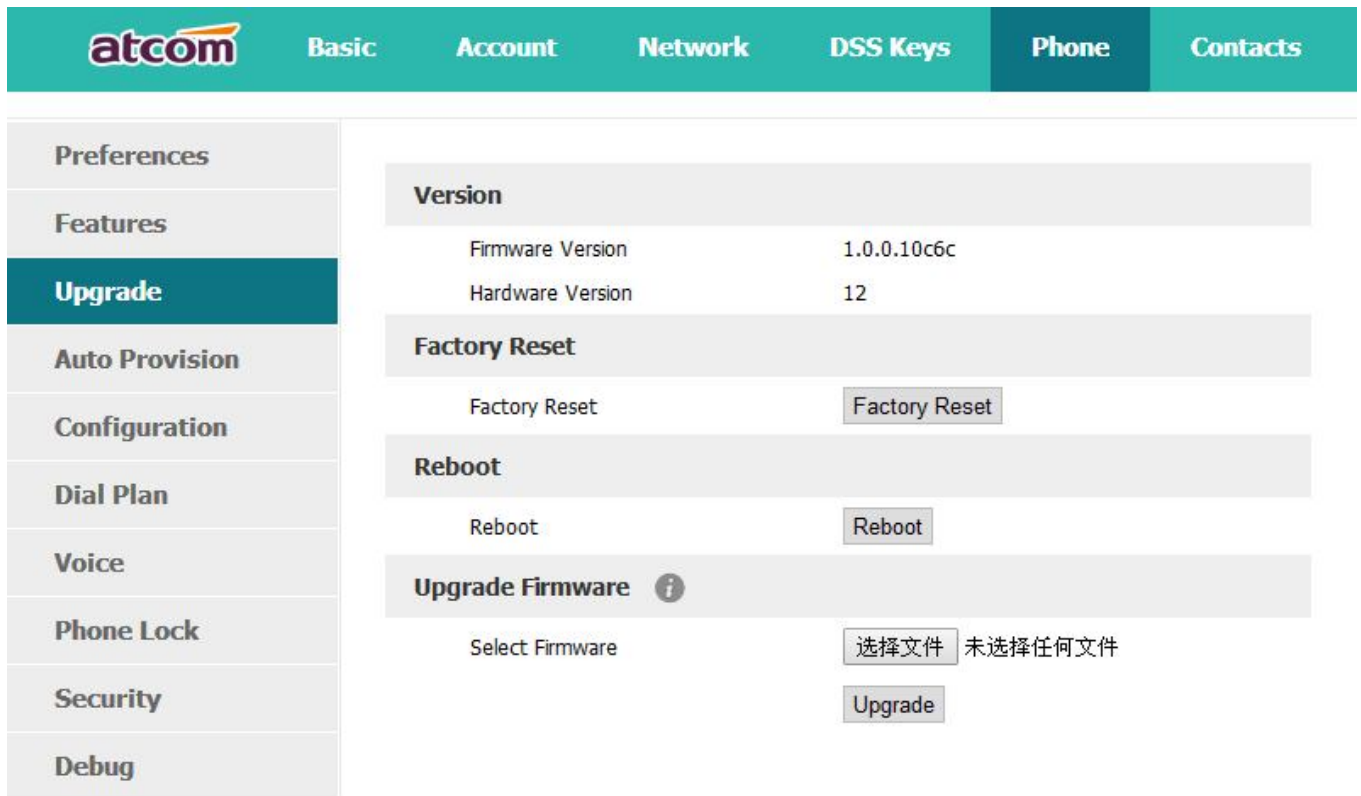



The screenshot shows the ATCOM web interface with the 'Phone' tab selected. The left sidebar contains the following menu items: Preferences, Features, Upgrade (highlighted), Auto Provision, Configuration, Dial Plan, Voice, Phone Lock, Security, and Debug. The main content area is divided into several sections:

- Version:** Displays 'Firmware Version' as 1.0.0.10c6c and 'Hardware Version' as 12.
- Factory Reset:** Includes a 'Factory Reset' button.
- Reboot:** Includes a 'Reboot' button.
- Upgrade Firmware:** Includes an information icon, a 'Select Firmware' label, a file selection button labeled '选择文件' (Choose file) with the text '未选择任何文件' (No file selected), and an 'Upgrade' button.

Before upgrading the firmware of phone, users are suggested to check the version of current firmware. Click the button "Choose file" to select the target local file and click "Upgrade" to process upgrading, this will cost a couple of minutes. And after reboot, the phone will be upgraded successfully.

4.3、 Auto Provision

User is able to configure the phone to upgrade automatically.

atcom		Basic	Account	Network	DSS Keys	Phone	Contacts
Preferences							
Features							
Upgrade							
Auto Provision							
Configuration							
Dial Plan							
Voice							
Phone Lock							
Security							
Debug							
Auto Provision							
PnP Active			<input checked="" type="radio"/> On <input type="radio"/> Off				
DHCP Active			<input checked="" type="radio"/> On <input type="radio"/> Off				
Provisioning Server			<input type="text"/>				
User Name			<input type="text"/>				
Password			<input type="text"/>				
Common AES Key			<input type="text"/>				
MAC-Oriented AES Key			<input type="text"/>				
Check New Config			<input checked="" type="radio"/> On <input type="radio"/> Off				
Repeatedly			<input type="radio"/> On <input checked="" type="radio"/> Off				
Interval(minutes)			<input type="text" value="1440"/>				
Weekly			<input type="radio"/> On <input checked="" type="radio"/> Off				
Time			<input type="text" value="03"/> : <input type="text" value="00"/> -- <input type="text" value="03"/> : <input type="text" value="00"/>				
Day of week			<input checked="" type="checkbox"/> Sunday <input checked="" type="checkbox"/> Monday <input type="checkbox"/> Tuesday <input type="checkbox"/> Wednesday				

Item	Description
Pnp Active	Select "On" or "Off" to enable or disable PNP automatic updates
DHCP Active	Select "On" or "Off" to enable or disable DHCP option automatic updates
Provisioning Server	The address to save control file for auto upgrading, it can filled by http、https、tftp server、ftp server, for example, tftp://192.168.1.111
User Name	The username to access the file server
Password	The password to access the file server
Common AES Key	Configures the plaintext AES key for decrypting the Common CFG file
MAC-oriented AES KEY	Configures the plaintext AES key for decrypting the MAC-oriented CFG file
Check New Config	If set this parameter as "On", the phone will do some check for

	upgrading, and it will upgrade automatically once the conditions are met
Repeatedly	If set this parameter as "On", the phone will do some check for upgrading after "Interval(minutes)", and it will upgrade automatically once the conditions are met
Interval(minutes)	This parameter is configurable once the Repeatedly is "On"
Weekly	If set this parameter as "On", the phone will do the check for upgrading at a certain time in every week
Time	The time range that the phone do the check for upgrading every week, and it's configurable once the Repeatedly is "On"
Day of week	The day of week that the phone do the check for upgrading every week, and it's configurable once the Repeatedly is "On"

4.4、 Export & Import configuration file

If user wants to set the same configuration on multiple phones, there is an easy way that export the configuration file from one phone and then import this file into other phones. This operation can be completed via Web only.

Note: This operation is available for the same models only.

Import / Export Config

Import File 

Choose file No file chosen

Export User Data

4.4.1、 Export configuration file

There is two ways to export the configuration files,

- Don't check the "Export User Data" and click "Export" directly, it will export the template of the configuration file;
- Check the "Export User Data" and then click "Export", it will export a configuration file that carries with user's configured data.

To modify the exported configuration file, you should to decompress it until you get a file names as configuration.

Name	Date modified	Size
configuration	2014/10/10 11:14	
config.tar.gz	2014/10/10 11:14	9 KB

The content of configuration file listed as below,

Name	Date modified	Type	Size
Calllist	2014/10/10 11:14	File folder	
Contacts	2014/10/10 11:14	File folder	
DialRule	2014/10/10 11:14	File folder	
Features	2014/10/10 11:14	File folder	
Network	2014/10/10 11:14	File folder	
Phone	2014/10/10 11:14	File folder	
Setting	2014/10/10 11:14	File folder	
voip	2014/10/10 11:14	File folder	

4.4.2、 Import configuration file

Click the button "Choose file" to select the target file for importing, and then click the button "Import". The phone will be rebooted a couple of minutes later, and import successfully.

Note: If some part of the configuration file has been modified manually, it must be re-compressed as the format of "tar.gz".

4.5、 Export System log

When the phone doesn't working well, System log is the best assistant tools for troubleshooting, all operation details has been recorded. This operation is available via Web only.

Export System Log

Log Location Local Server i

Server Name

Log Level

Item	Description
Log Location	You can import the system log to local PC or remote Server.
Server Name	User must fill the address of server if you choose to export the system log to remote server.
Log Level	It defines the detail of system log as 5 different levels, Fatal, Error, Warning, Info, and Debug. The Debug level is the most detailed.

4.6、Dial plan

The customized Dial Plan are available on Rainbow 4 (s) , for example , the rule of replacement, Instant Calling, Area code, Restriction of Outbound.

Before customizing the dial plan, user must learn the basic grammar as below,

.	Represent a character or multiple ones, e.g., "6." can match "66", "678", "6plus" and so on
x	Represent one character, e.g., "6x" can match "61", "62", " 6s" and so on
[]	Represent a character in one range, e.g., " 83[0-5]18618" can match "83018618", "83488618" and so on
()	Represent the combination of characters, e.g., "([1-9])([2-7])3" can match "923", "153", "773" and so on

\$	Add a number after the character "\$" to define the location of the characters, e.g., use the prefix " 8([1-3])(.)" to replace "7\$2", the phone will call "7837" after dialing out "82837"
----	---

Note: Any operations (add, modify or delete) on the current dial plan will be not effective until click "Save".

4.6.1、Replace Rule

Dial plan "Replace Rule" means to replace a batch of complicated character string by some simple characters, to make a speed dial.

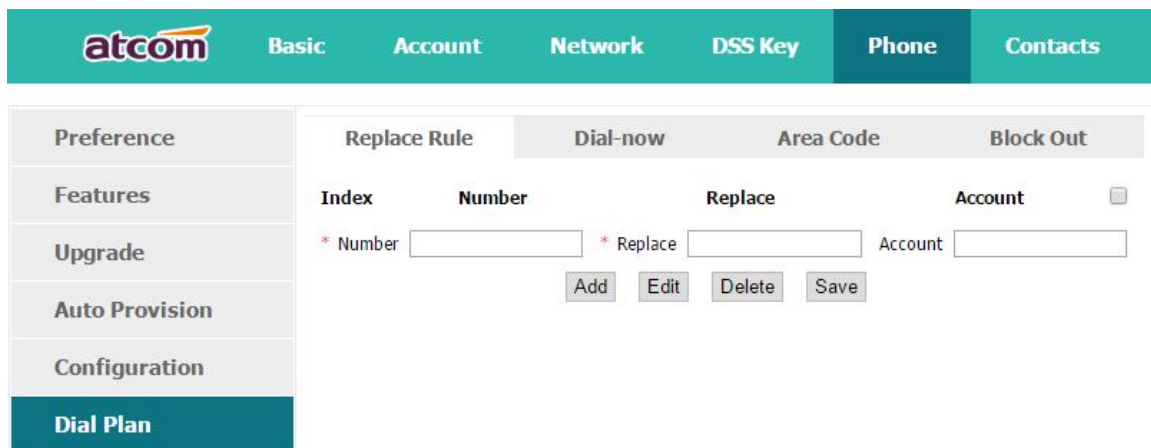

Item	Description	Sample
Number	The string works as replacer, not null	Set Number as "6",
Replace	The string that to be replaced, not null	Set Replace as "6032",
Account	The account to apply this dial plan, blank or 1 to 6 is valid. Number 1 to 6 means account 1 to 6. If you want to apply this rule to account 1、3 and 4, just type in 1,3,4 ; And if keep it as blank, it means applying this dial plan to all accounts	Set Account as "1,3,4". It means when dial 6, the phone will dial 6032 via the 1st available line in account 1,3,and 4 automatically
Add	Multiply replace rules can be configured in one phone, after one replace dial plan configured, click this button to add a new one	

Edit	The existed replace dial plans are editable. The specified dial plan should be selected until it is covered with orange and the input fields "Number" and "Replace" shows the details correctly. After modifying, click button "Edit" to make it to be effect	
Delete	Delete one added or saved replace dial plan or multiple ones, click the frame after the specified replace dial plan before delete it, and then click button "Delete"	
Save	Any alteration won't take effect until the button "Save" is clicked.	

4.6.2、Dial-now

Dial plan "Dial-now" permits the corresponding phone to be dialed instantly without pressing the soft key "Dial", once the input has been matched. It works like a hotline.

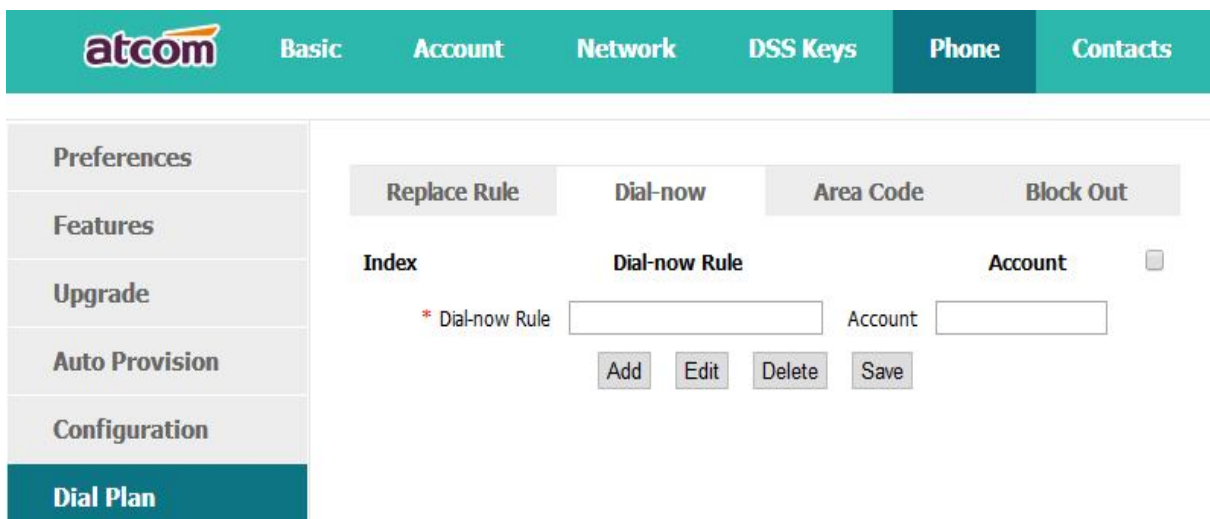

The screenshot shows the atcom web interface. The top navigation bar includes 'Basic', 'Account', 'Network', 'DSS Keys', 'Phone', and 'Contacts'. The left sidebar has 'Dial Plan' selected. The main content area shows the 'Dial-now' configuration page. It has tabs for 'Replace Rule', 'Dial-now', 'Area Code', and 'Block Out'. Under the 'Dial-now' tab, there is a table with columns 'Index', 'Dial-now Rule', and 'Account'. A red asterisk indicates a required field. Below the table are buttons for 'Add', 'Edit', 'Delete', and 'Save'.

Item	Description	Sample
Dial-now Rule	The string to be dialed out automatically by the phone	Set "Dial-now Rule" as 6xxx, keep

Account	The account to apply this dial plan, blank or 1 to 6 is valid. Number 1 to 6 means account 1 to 6. If you want to apply this rule to account 1、3 and 4, just type in 1,3,4 ; And if keep it as blank, it means applying this dial plan to all accounts	“Account” as null It means the phone will use the 1st available account to call 6033 after “Dial-now Time-out” seconds when inputting four figures begin with 6
Add	Multiply dial-now rules can be configured in one phone, after one dial-now dial plan configured, click this button to add a new one	Note: Dial-now rule is different with hotline. The Dial-now rule will take effect when input numbers matches the dial plan, and hotline takes effect in situation that the phone is in dialing state
Edit	The existed dial-now dial plans are editable. The specified dial plan should be selected until it is covered with orange and the input fields “Number” and “Dial-now” shows the details correctly. After modifying, click button “Edit” to make it to be effect	
Delete	Delete one added or saved dial-now dial plan or multiple ones, click the frame after the specified dial-now dial plan before delete it, and then click button “Delete”	
Save	Any alteration won’t take effect until the button “Save” is clicked.	

Set “Dial-now Time-out” via web: **Phone→Features→General Information→Dial-now Time-out (secs).**

4.6.3、Area Code

Dial plan “Area Code” has been defined to identify each different area. To call a phone number of other areas, user must add the area code to be in front of the phone number. For convenience, area code has been recommended to be configured while frequently dialing to that type of phone number.

atcom						
Basic		Account	Network	DSS Key	Phone	Contacts
Preference	Replace Rule	Dial-now	Area Code	Block Out		
Features	Code	<input type="text"/>	<input type="text"/>	<input type="text"/>		
Upgrade	Minimum length	<input type="text" value="8"/>	<input type="text" value="15"/>	<input type="text"/>	(1~15)	(1~15)
Auto Provision	Maximum length	<input type="text" value="15"/>	<input type="text" value="8"/>	<input type="text"/>	(1~15)	(1~15)
Configuration	Account	<input type="text"/>	<input type="text"/>	<input type="text"/>		
Dial Plan			<input type="text"/>			
		<input type="button" value="Confirm"/>	<input type="button" value="Cancel"/>			

Item	Description	Sample
Code	The area code dialed before the number	Set "Code" as "0086577", Set "Account" as "5",
Minimum length	The minimum length of the number input to activate the area code dial plan	Set "Minimum length" as "5".
Maximum length	The maximum length of the number input to activate the area code dial plan	It means when dialing 83018618 with the 5 th account, the phone will dial 0086577 before it.
Account	The account to apply this dial plan, blank or 1 to 6 is valid. Number 1 to 6 means account 1 to 6. If you want to apply this rule to account 1、3 and 4, just type in 1,3,4 ; And if keep it as blank, it means applying this dial plan to all accounts	Note: If the length of the number input in the dial UI is not between minimum length and the maximum length, area code will not take effect
Confirm	Apply this dial plan	
Cancel	Recover all input fields to the state that saved at latest time	

4.6.4、Block Out

Dial plan "Block out" is used to prohibit the phone number outgoing call from some accounts.

atcom Basic Account Network DSS Keys Phone Contacts



- Preferences
- Features
- Upgrade
- Auto Provision
- Configuration
- Dial Plan**
- Voice
- Phone Lock
- Security
- Debug

Replace Rule	Dial-now	Area Code	Block Out
Block Out Number1	<input type="text"/>	Account	<input type="text"/>
Block Out Number2	<input type="text"/>	Account	<input type="text"/>
Block Out Number3	<input type="text"/>	Account	<input type="text"/>
Block Out Number4	<input type="text"/>	Account	<input type="text"/>
Block Out Number5	<input type="text"/>	Account	<input type="text"/>
Block Out Number6	<input type="text"/>	Account	<input type="text"/>
Block Out Number7	<input type="text"/>	Account	<input type="text"/>
Block Out Number8	<input type="text"/>	Account	<input type="text"/>
Block Out Number9	<input type="text"/>	Account	<input type="text"/>
Block Out Number10	<input type="text"/>	Account	<input type="text"/>

Item	Description	Sample
Block Out Number	The number that prohibited	Set "Block Out Number 1" as "10086"
Account	The account to apply this dial plan, blank or 1 to 6 is valid. Number 1 to 6 means account 1 to 6. If you want to apply this rule to account 1、3 and 4, just type in 1,3,4 ; And if keep it as blank, it means applying this dial plan to all accounts	Set "Account" as "2,4,6" It means the phone will enter the "Call End" UI when dial "10086" with account 2, 4 or 6
Confirm	Apply this dial plan	
Cancel	Recover all input fields to the state that saved at latest time	

5、WI-FI(only for A68W)

5.1、Configure the wifi on the phone

- 1、 Press  "Menu"->"Settings"->"Advanced Settings"->"Network"->"Connect Mode",change for the wifi connection mode,press "Save".
- 2、 Press  "Menu"->"Settings"->"Advanced Settings"->"Network"->"WIFI setting"->"WLAN" choose the wifi you want to connect,Press "Connect",then input the correct wifi password.
- 3、 Return to the standby interface,and phone successful connected to the wifi.

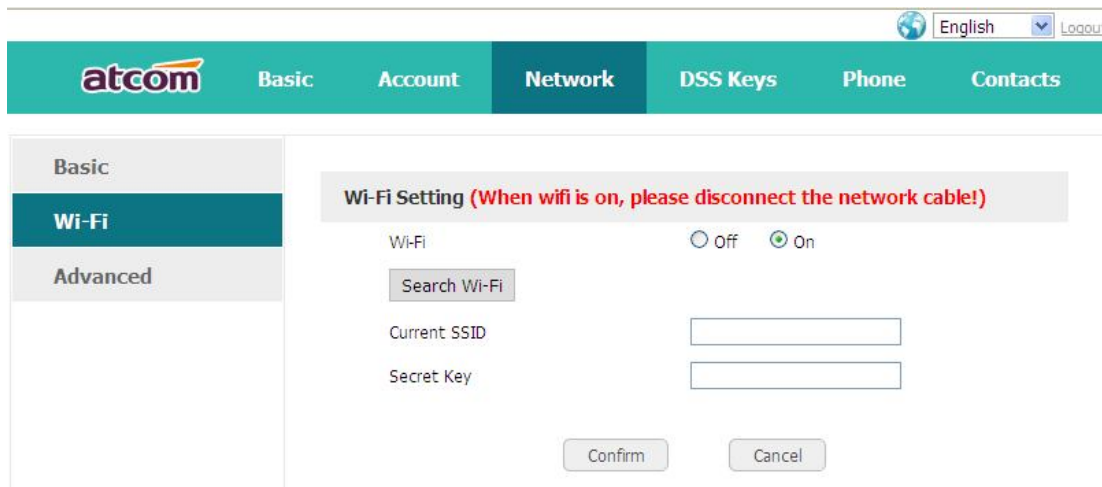

5.2、Configure the wifi on the WEB

A68W connect to network via Wi-Fi acquiescently, click "Search Wi-Fi" button to search the available Wi-Fi.



After all available Wi-Fi hotspots are list out, click the round behind the available Wi-Fi which you want to connect.

Index	SSID	Signal	Select
1	cisco	211	<input type="radio"/>
2	360	207	<input type="radio"/>
3	re	207	<input type="radio"/>
4	amoji	205	<input type="radio"/>
5	CHINA TELECOM	205	<input type="radio"/>
6	360_____WIFI-C9	197	<input type="radio"/>
7	_____	197	<input type="radio"/>
8	_____	190	<input type="radio"/>
9	inWatch3	189	<input type="radio"/>
10	ChinaNet-7A6t	188	<input type="radio"/>
11	360_____WIFI-9F	185	<input type="radio"/>
12	iTV-7A6t	185	<input type="radio"/>
13	inWatch2	185	<input type="radio"/>
14	Royale International China	184	<input type="radio"/>

Input the right "**Secret Key**" and then click the "**Confirm**" button, the phone will reboot, after rebooting, the Wi-Fi icon will display on the home screen, it means connect failed when the icon come with , then you should check the configuration. if the icon come with , it means connect successfully.

6、FAQ

6.1、How to reset to factory

There are 3 methods for factory reset:

1. Factory reset via phone:

- a) Press the key 
- b) Select "Settings", then press the soft key "Enter"
- c) Select "Advanced Settings", then press the soft key "Enter"
- d) Input the access password, then press the soft key "Enter"
- e) Select "Reset to factory", then press the soft key "Enter"
- f) Press the soft key "OK", then the phone will be reboot and resumed to factory default settings

2. Factory reset via Web:

- a) Key in the IP address of phone with a browser,
- b) Access the webpage of phone as the role of "admin", username/password is admin/admin.
- c) Select "Phone"
- d) Select "Upgrade"
- e) Click the button "Reset to Factory"
- f) Click the button "OK"

3. Factory reset during starting:

- a) Hold the key "*" and "#" while power on for 5 seconds
- b) The phone will be reboot and resumed to factory default setting

6.2、 Upgrade the firmware on safe mode

If the phone can't be started successfully, user is able to upgrade the firmware on post mode,

- a) Setup a TFTP Server and set the PC's IP address as "192.168.1.200"
- b) Copy the firmware file we supplied to the root menu of TFTP Server, modify the file's name as A68(W).tar.gz and decompress it, then modify the corresponding file's name as A68(W).kn, A68(W).fs, A68(W).fw, A68(W).lg
- c) Ensure the TFTP Server and phone are connected to the same network switch and both reachable
- d) Long Press the key "*" and "1" to upgrade the kernel file, long Press the key "*" and "2" to upgrade the firmware file, long Press the key "#" to upgrade the App file, long Press the key "*" and "4" to upgrade the logo file, and then plug in power until "upgrading..." displayed on LCD
- e) The phone will start downloading file from TFTP server
- f) After downloading completed, the phone will be automatically upgraded

g) After upgrading completed, the phone will be started with the factory default settings

6.3、 How to make IP Peer to Peer call

To make a IP peer to peer call, user should press "*" to input "." that in the IP address. For example, to dial "192.168.1.100", just need input "192","*","168", "*","1", "*","100".

7、 Troubleshooting

7.1、 The phone is failed to register to SIP server

1. First of all, check the IP address. If the LAN port is DHCP, please ensure the DHCP server has been enabled.
2. Check the network gateway
3. Check the DNS
4. Make sure the input account matched the one provided by Service Provider
5. Make sure SIP Server has been enabled already
6. Make sure the Port of SIP Server, it's 5060 by default

7.2、 The phone is failed to gain IP address

1. Make sure the network cable has been plugged into the LAN port

2. Make sure the network cable or port of network switch are working fine,
3. Make sure the DHCP server has been enabled, and there are available IP address
4. Try to set the LAN port as Statics IP

7.3、 Only one party can hear from another on calling

1. Try to make a IP peer to peer call, to make sure the mic and speaker are working fine
2. Enable STUN via Web
3. Set the address of STUN Server, for example stun.sipgate.com
4. Present this operation above and the phone will be reboot
5. Try to make a normal call again

8、 Abbreviation

DND: Do Not Disturb

CFWD: Call Forward

Bxfer: Blind Transfer

Conf: Conference

Num: Number

SIP: Session Initiate Protocol

RTP: Real-time Transport Protocol

SDP: Session Description Protocol

VPN: Virtual Private Network

VLAN: Virtual Local Area Network

QoS: Quality of Service

Syslog: System log

UDP: User Data Protocol

TCP: Transmission Control Protocol

TLS: Transport Layer Security Protocol

BLF: Busy Lamp Field

DNS: Domain Name System

SRTP: Secure Real-time Transport Protocol

NTP: Network Time Protocol

VAD: Voice Activity Detection

CNG: Comfort Noise Generator